

MECADEMIC

INDUSTRIAL ROBOTICS



MECA500 INDUSTRIAL ROBOT

USER MANUAL

Document ID: MC-UM-MECA500-EN

For Firmware Version 10.2

Document Revision: A

The information contained herein is the property of Mecademic and shall not be reproduced in whole or in part without prior written approval of Mecademic. The information herein is subject to change without notice and should not be construed as a commitment by Mecademic. This manual will be periodically reviewed and revised.

While every effort has been made to ensure accuracy in this publication, no responsibility can be accepted for errors or omissions. Data may change, as well as legislation, and you are strongly advised to obtain copies of the most recently issued regulations, standards, and guidelines.

This document is not intended to form the basis of a contract.

Original instructions

© Copyright 2015–2024 Mecademic

CONTENTS

1. INTRODUCTION	1
1.1. Inside the box.....	1
1.2. Overall description	2
1.3. Applied standards.....	3
2. SAFETY	4
2.1. Operating modes	5
2.2. Power supply unit (PSU) and safety	6
2.2.1 Locking up the power supply.....	7
2.3. Robot arm and safety.....	8
2.3.1 Brakes and limitations.....	8
2.3.2 Releasing the brakes	10
2.3.3 Stopping times and distances	10
2.3.4 Joint limits	11
2.3.5 Joint torque limits.....	11
2.3.6 Loss of Ethernet connection.....	11
3. TECHNICAL SPECIFICATIONS	12
4. INSTALLING THE ROBOT SYSTEM	16
5. OPERATING THE ROBOT	18
5.1. First-time use	18
5.1.1 D-Sub dongle (first time use and maintenance only)	18
5.1.2 Configuring your Ethernet connection (first time use).....	18
5.2. Power-up procedure.....	19
5.2.1 Powering the robot	19
5.2.2 Connecting to the robot.....	19
5.2.3 Changing the robot's network configuration (optional)	20
5.2.4 Activating and homing the robot	21
5.2.5 Testing joint 6.....	21
5.2.6 Moving the robot	21
5.2.7 Testing the E-STOP button and the brakes (first time use)	22
5.3. Power-off procedure.....	23
5.3.1 Zeroing the robot joints	23
5.3.2 Deactivating the robot	23
5.3.3 Disconnecting the robot.....	23
5.3.4 Removing power	23
5.4. Robot control panel	24
5.4.1 Buttons.....	24
5.4.2 LEDs.....	25
5.5. Offline mode (for demonstrations only)	26
5.5.1 Saving the program via the web interface.....	26
5.5.2 Running an offline program	26

6. THE MECAPORTAL	28
6.1. Updating the robot's firmware	28
6.2. Overview.....	29
6.3. The menu bar.....	29
6.3.1 The connection and robot state selectors.....	30
6.4. The code editor panel.....	30
6.4.1 Using programs.....	30
6.4.2 Writing programs.....	31
6.4.3 Executing programs.....	32
6.5. The event log panel.....	32
6.6. The 3D view panel.....	33
6.6.1 The robot position display.....	33
6.7. The jogging panel	34
6.7.1 The joint jog tab	35
6.7.2 The Cartesian jog tab.....	38
6.8. The configuration menu	39
7. OPERATING THE SMART POWER SUPPLY	41
7.1. Emergency, protective and software stops	41
7.2. LEDs.....	42
7.3. External connections.....	43
7.3.1 Stop Category 1 Emergency Stop	44
7.3.2 Stop Category 1 Protective Stop (P-Stop 1).....	44
7.3.3 Software Stop (SWStop).....	45
7.3.4 External Reset.....	46
7.3.5 Power Status.....	47
8. INSTALLING AN END-EFFECTOR.....	49
9. EXAMPLES	50
9.1. Draw a square.....	50
10. INSPECTION AND MAINTENANCE	51
11. TROUBLESHOOTING	52
12. DECOMMISSIONING	54
APPENDIX 1. MECA500 R4 EMC TEST RESULTS	55
APPENDIX 2. MECA500 R3 EMC TEST RESULTS	57



ABOUT THIS MANUAL

There are two manuals that come with the Meca500 industrial robot system (revision R3 or R4): this one and the Programming Manual for Mecademic robots. The present manual will guide you through the steps required for setting up your Meca500 and for using it in a safe manner. You must read this user manual thoroughly during the unpacking and first use of your Meca500.

Keep this manual for future reference.

Symbol definitions

The following table lists the symbols that may be used in Mecademic manuals to denote certain conditions. Particular attention must be paid to the warning messages in this manual.

SYMBOL	DEFINITION
	NOTICE. Identifies information that requires special consideration.
	CAUTION. Provides indications that must be respected in order to avoid equipment or work (data) on the system being damaged or lost.
	WARNING. Provides indications that must be respected in order to avoid a potentially hazardous situation, which could result in injury.

Revision history

The firmware that is installed on Mecademic products has the following numbering convention:

{major}.{minor}.{patch}.{build}

Each Mecademic manual is written for a specific {major}.{minor}.{*}.{*} firmware version. On a regular basis, we revise each manual, adding further information and improving certain explanations. We only provide the latest revision for each {major}.{minor}.{*}.{*} firmware version. Below is a summary of the changes made in each revision.

REVISION	DATE	COMMENTS
A	June 13, 2024	Original version.

The document ID for each Mecademic manual in a particular language is the same, regardless of the firmware version and the revision number.

References

The following documents are referred to in this user manual:

Document title	Document ID
Mecademic Industrial Robots - Programming Manual	MC-PM-EN
MPM500 Pneumatic Module - User Manual	MC-UM-MPM500-EN
MEGP 25E/25LS Electric Parallel Grippers - User Manual	MC-UM-MEGP25-EN

These documents are available as PDF files on Mecademic's web site.

1. INTRODUCTION





The Meca500 is a six-axis industrial robot arm intended for displacing tools and workpieces within factory or laboratory environments, with high precision and with six degrees of freedom. The Meca500 is easy to use, robust and lightweight. However, the robot is a precision device with rapidly moving parts and should therefore be used only by trained technical personnel who have read and understood this user manual, to avoid damages to the robot, its end-effector, any workpiece and adjacent equipment, and, most importantly, to avoid injuries.

1.1. Inside the box

Remove all items carefully and do not discard your shipping box and packing foam.

Table 1 shows the items that come with a standard shipment of a Meca500 robot system. Your box may also contain the MEGP 25E or MEGP 25LS electric gripper, the MPM500 pneumatic module, or other small accessories. Do not open these additional packages immediately. You must read the grippers or pneumatic module user manuals prior to installing the end-of-arm-tooling (EOAT) on the robot.

Table 1: Standard parts list

Qty	SKU	Description	Photo
1	9100-001 OR 9100-002	Meca500 robot arm, revision R3 OR Meca500 robot arm, revision R4	
1	9200-001 OR 9200-003	24 V DC PS200 smart power supply, revision R3 OR 24 V DC PS200 smart power supply, revision R4	
1	9403-001	D-Sub 15-pin dongle	
1	2003-005	Ethernet cable: 2-meter M12 D-Code to RJ45	
1	2003-006	DC power cable: M12 circular male to M12 circular female DC power cable	



Note, that you must provide your own AC power cord, with three-prong IEC C13 connector on one end, and your own country's power plug on the other, as well as a surge protector. You must also provide M6 screws of proper length for attaching the robot's base and the power supply.

1.2. Overall description

Figure 1 shows a schematics of the complete Meca500 robot system in a typical installation. The D-Sub 15-pin dongle provided is not shown as it must be used only during setup and testing. As for the surge protector, we suggest using the ASCO Model 241 from Schneider Electric.

The Meca500 robot arm consists of seven bodies connected in series through six motorized revolute joints. The first body is the robot base and the seventh body is the flange (mechanical interface). The joints are numbered from 1 to 6, starting from the joint connected to the base, and are labeled on the robot as A1, A2, ..., A6.

Joints 1, 2 and 3 are equipped with emergency brakes, which are automatically applied when power is removed from the motors. Joints 4, 5 and 6 have no brakes.

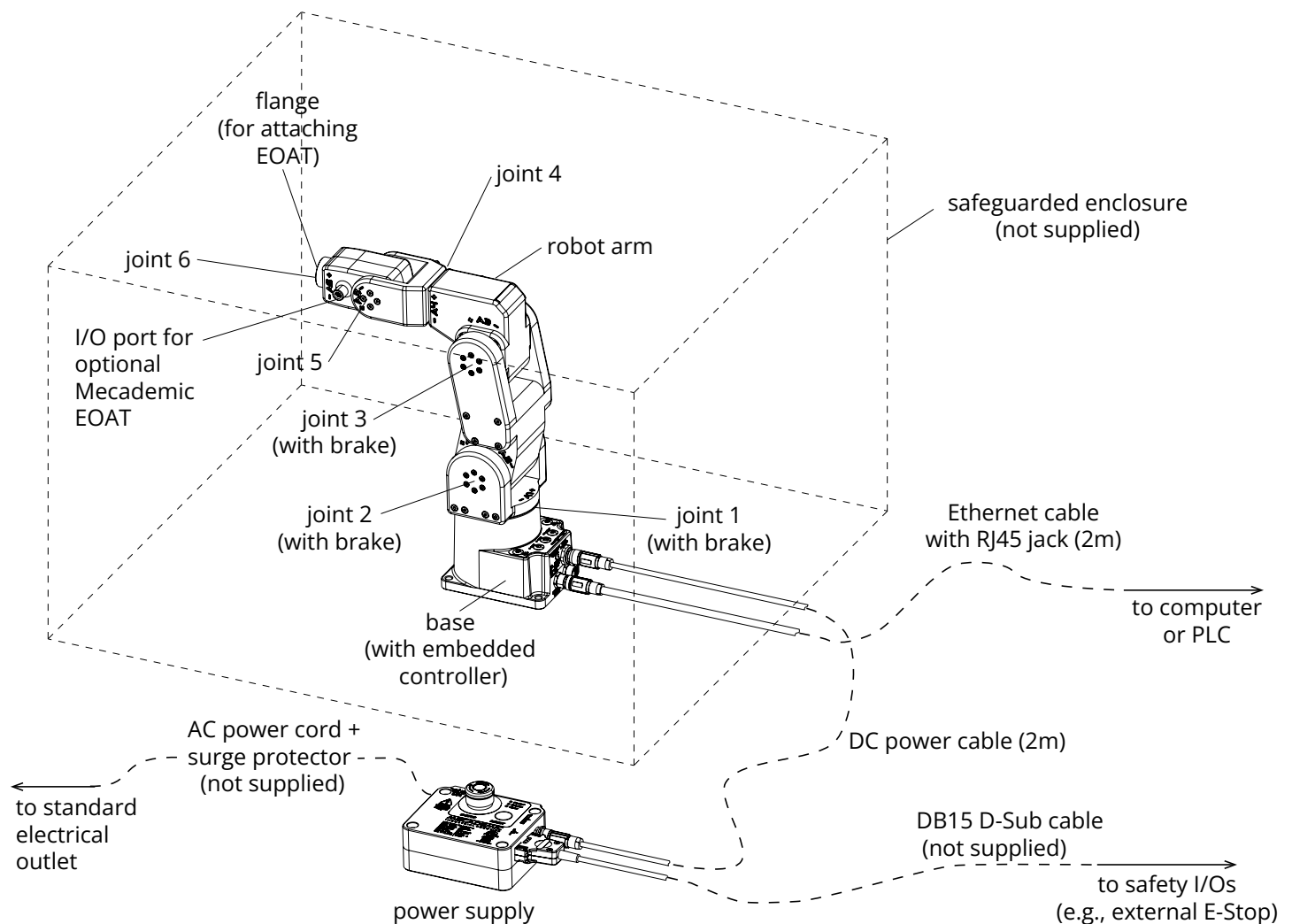

Figure 1: Schematics of the Meca500 robot system installed

1.3. Applied standards

The Meca500 R4 and its power supply comply with the following European directives and harmonized standards:

- Machinery directive 2006/42/EC
- EN EIC 61326-1:2021 (Electrical equipment for measurement, control and laboratory use - EMC requirements - Part 1: General requirements)
- EMC directive 2014/30/EU
- Low voltage directive 2014/35/EU
- RoHS Directive (EU) 2015/863
- Harmonic Current Emission Limits EN IEC 61000-3-2 (2019) A1 (2021)
- Voltage Fluctuations and Flicker Limitations EN 61000-3-3 (2013) A1 (2019) A2 (2021)
- Electrostatic Discharge Immunity IEC 61000-4-2 (2008)
- Radiated Electromagnetic Field Immunity IEC 61000-4-3 (2020)
- Electrical Fast Transient Immunity IEC 61000-4-4 (2012)
- Surge Immunity IEC 61000-4-5 (2014) A1 (2017)
- Immunity to Conducted Disturbances, Induced by Radio-Frequency Fields IEC 61000-4-6 (2013)
- Power Frequency Magnetic Field Immunity IEC 61000-4-8 (2009)

Further details related to EMC are given in [APPENDIX 1](#) and [APPENDIX 2](#).

In addition, the design of the Meca500 R4 robot arm and its power supply was guided by the following harmonized standards, incorporating a tailored approach to meet our unique objectives:

- ISO 10218-1:2011 (Robots and robotic devices – Safety requirements for industrial robots. Part 1: Robots)
- IEC 60204-1:2016 (Safety of machinery – Electrical equipment of machines. Part 1: General requirements)
- ISO 13849-1:2015 and ISO 13849-2:2012 (Safety of machinery – Safety-related parts of control systems)
- ISO 13850:2015 (Safety of machinery – Emergency stop – Principles for design)

The following two EU declarations (certificates) are available separately, as PDF files on Mecademic's website:

- EU Declaration of Conformity for Meca500 R4 (CE Certificate)
- EU Declaration of Incorporation for Meca500 R3 (DOI Certificate)



2. SAFETY

The Meca500 weighs less than 5 kg, however, it can move fast and cause injuries, especially when certain end-effectors are attached to its flange (e.g., a sharp tool or a laser). The robot includes three openings known as *pinch points* where robot links may squeeze a finger (Figure 2). These areas are indicated with a yellow triangular label depicting a crushed hand

Finally, the Meca500 does not have brakes on its last three joints; the tooling can therefore cause injuries under the effects of gravity or inertia.



In the shipping position, the robot can be temporarily deposited on its base. In other robot positions, the robot may tip and should not be placed on its base without fixing it. If the robot tips and falls from a height, it may cause an injury, and will certainly get damaged.



- Handle the robot with care.
- The Meca500 is equipped with brakes on its first three joints (the ones close to the base). When the robot is not activated, these brakes are automatically applied. Do not overpower the robot brakes, unless there is an emergency!
- Inspect the robot and power supply for damages. If either appears damaged, do not use them and contact us immediately.
- Do not modify or disassemble the robot or the power supply. This will void your warranty.
- Do not use or store the Meca500 in a humid environment or outdoors.
- Do not operate the Meca500 at temperatures below 5°C or above 35°C.
- Use only the power supply provided with your system.
- Use only the Ethernet and DC-power cables provided. Contact us if you need longer cables.



Figure 2: Keep your fingers away from the three pinch points of the Meca500

2.1. Operating modes

Because of the robot's small size, it is not equipped with an operating mode switch and can operate only in automatic mode. Therefore, the robot does not require a three-position enabling device, but must be operated inside a safety enclosure (as in [Figure 3](#)).

The power supply of the Meca500 must be outside the safety enclosure.



The Meca500 is not designed for collaborative robot applications. Furthermore, it can operate only in automatic mode. Therefore, it must be operated inside a safety enclosure. Human operators must not enter the safeguarded zone while the robot motors are powered.



You must follow the guidelines of ISO 12100:2010 and ISO 10218-2:2011 and conduct a risk assessment of your complete robot cell, including the Meca500, its end-effector and all adjacent equipment.



During non-routine operating conditions, such as setup and maintenance, it is imperative to wear safety goggles. Additionally, ensure not to wear loose-fitting clothing or have loose long hair that could potentially get entangled in the robot.



Figure 3: The Meca500 must be operated inside a safety enclosure (photo courtesy of Mati Therapeutics)

2.2. Power supply unit (PSU) and safety

The PS-200 power supply integrates several safety features. Use only the power supply provided by us to power your Meca500 robot arm. The Meca500 will not function with the power supply of another revision or with a third-party 24 V DC power supply.

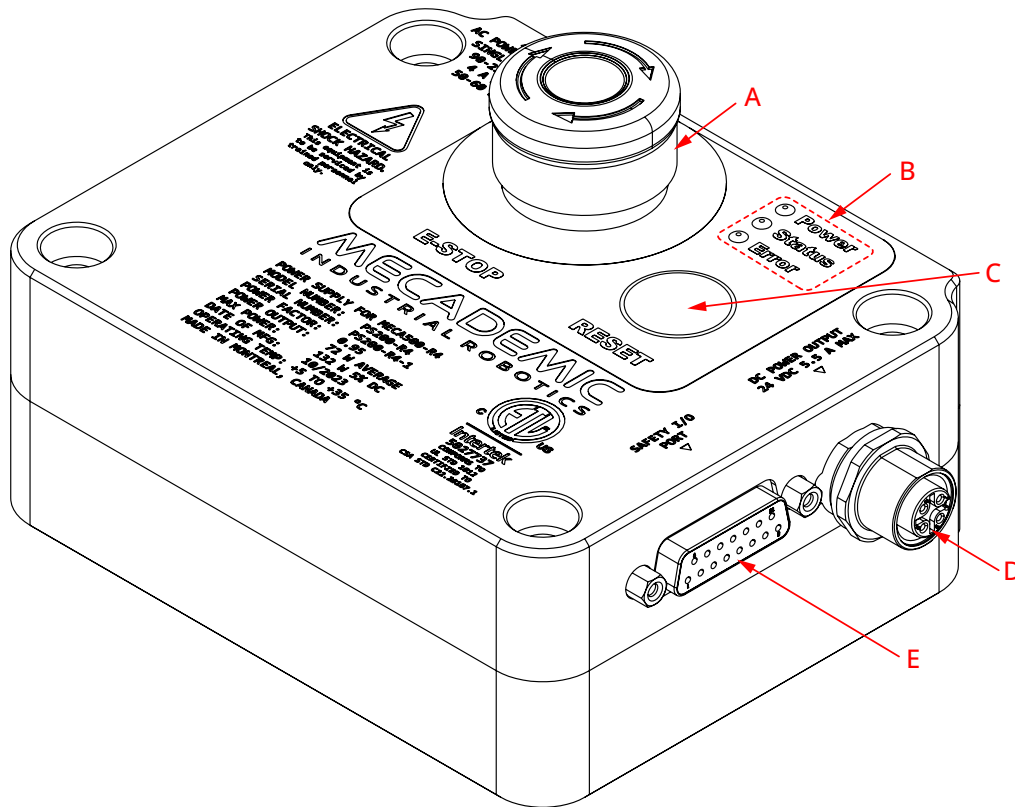

Figure 4: PS200 power supply features



The latest, R4, revision of the Meca500 incorporates one major change compared to version R3: the E-Stop no longer cuts power to the complete robot, but only to the motor drives. Do not use the power supply of an R3 version with a Meca500 R4, and vice versa. The R4 robot arms and power supplies are clearly indicated as being R4.

Figure 4 shows the Meca500 power supply unit (PSU) with safety module. Its main features are:

- A: Emergency stop button (Stop Category 1), designed to achieve PL=d.
- B: Power, Status and Error LEDs.
- C: Reset button.
- D: 24 V (DC) power and communications cable port (for connecting to robot);
- E: D-Sub 15-position interface for connecting safety I/O.

Figure 5 shows the AC power connector, of type IEC C14, and indicates the Neutral (N), Protective Earth (PE) and Live (L) pins. It also illustrates the main switch ("I" stands for ON, "O" stands for OFF).

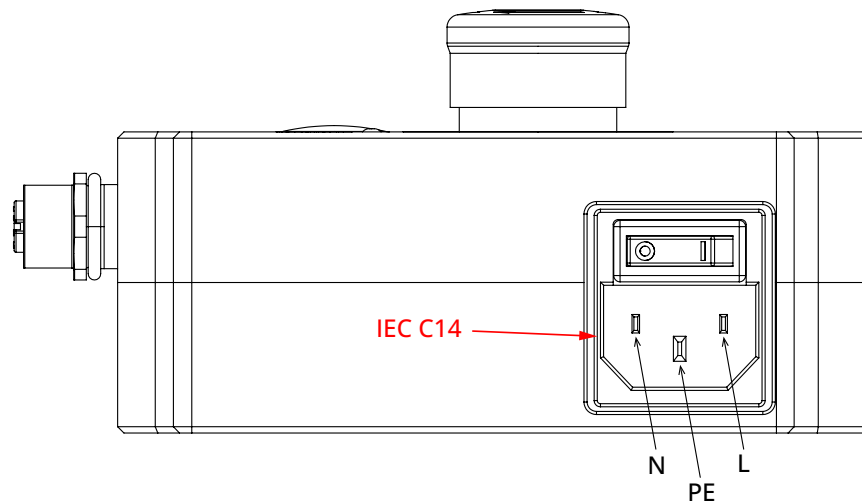

Figure 5: Power supply AC power connector and main switch

The E-Stop circuit of the Meca500 (E-STOP button on PSU and optional external E-Stop buttons that are properly connected) meets the performance level required by ISO 10218-1:2011 (5.4.2) which is PL=d with a circuit structure of Category 3 based on ISO 13849-1:2006. As per ISO 10218-1:2011 (5.4.2), a Category 3 structure means that:

- A single fault in any subcomponent does not lead to the loss of the safety functions.
- The single fault shall be detected at or before the next demand upon the safety function.
- When the single fault occurs, the safety function is always performed and a safe state shall be maintained until the detected fault is corrected.

Safety equipment connected to the Protective Stop 1 function on the D-Sub connector safety input also meet the same requirements and are PL=d and Category 3.

The E-Stop and Protective Stop 1 circuits on the Meca500 are Stop Category 1, as per ISO 13850:2008 (4.1.4). Once the stop is initiated, the robot arm will stop any motion in a controlled manner in less than 150 ms. The power is removed from the robot (R3) or from the robot's motors (R4) after 450 ms regardless of the state of the system.

The E-Stop and Protective Stop 1 inputs are redundant with two separate channels and monitoring circuitry is used to ensure that no tampering is possible. This means the inputs must switch states in tandem within 50 ms otherwise a Stop Category 0 will occur (power is removed from the motors).

In order to be able to use the Meca500, you must properly connect your safety inputs on the D-Sub 15-position interface, as described in [Section 7](#) or temporarily connect the D-Sub dongle.

2.2.1 Locking up the power supply

To prevent unauthorized or accidental powering of the robot, we suggest unplugging the AC cord and using a detachable IEC Plug Lockout device such as the one from Brady.

2.3. Robot arm and safety

Figure 6 shows a description of the main components of the Meca500 robot arm.

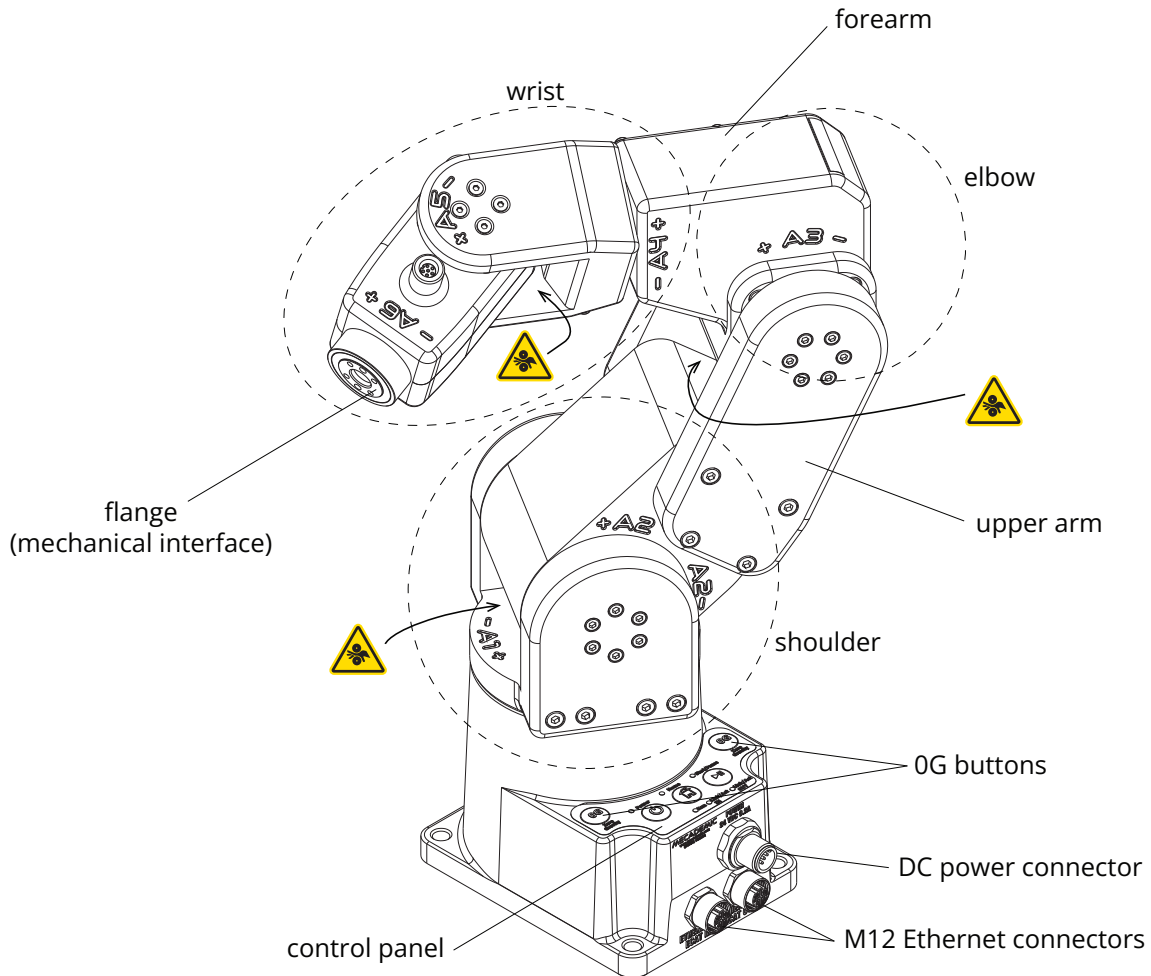

Figure 6: Meca500 robot arm

2.3.1 Brakes and limitations

As already mentioned, the Meca500 has brakes on joints 1, 2 and 3 only. Therefore, when the robot is deactivated, powered off, or put in safety stop (E-Stop or Protective Stop 1), the brakes on joints 1, 2 and 3 will be immediately applied and the joints will be immobilized instantly. Simultaneously, since joints 4, 5 and 6 do not have brakes, they will become free. This minimizes the risks of pinning and pinching from the wrist and the end-effector. However, beware that the end-effector might slowly move downwards under the effects of gravity, as shown in Figure 7. Depending on the type of end-effector used, this residual motion might lead to an injury.



Figure 7: When the robot is deactivated, the end-effector will slowly move downwards under the effects of gravity



Beware that the end-effector might slowly move downwards under the effects of gravity or inertia when you deactivate the robot (e.g., by pressing the E-STOP button).

In addition, remember that the brakes used on joints 1, 2 and 3 are emergency brakes, not locking brakes. Therefore, if you leave the robot in a configuration where the robot's upper arm and forearm are nearly horizontal, the robot will slowly fall down under the effects of gravity, especially if you have the maximum payload. For example, if you deactivate the robot in the configuration shown in [Figure 8a](#), the robot's gripper might eventually collide with the table.



Before leaving the robot deactivated or powered off for an extended period of time, bring it to a position that minimizes the static torques on joints 1, 2 and 3 (see [Figure 8](#)).



(a) DO NOT leave the robot deactivated like this

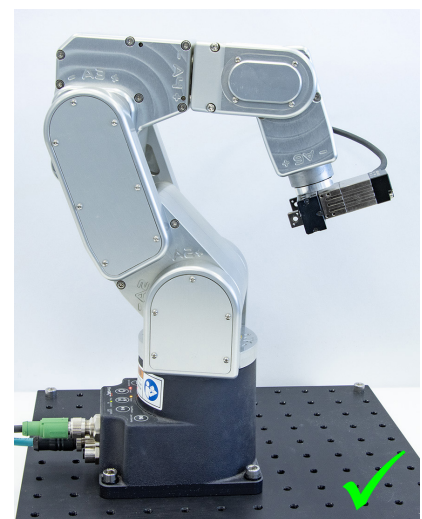

(b) DO leave it like this

Figure 8: Before leaving the robot for a long period of time, move it to a position that minimizes the joint torques

2.3.2 Releasing the brakes

You can disable the brakes of joints 1, 2 and 3, ONLY if the robot motors are powered AND the robot is deactivated. (There are no purely mechanical means for doing so.) This means that the E-Stop or protective stop should not be activated, which does not meet the requirements of ISO 10218-1:2011.

The only situation where you might need to disable the robot brakes and move the robot by hand, is if you are about to power up the robot, but some of its links are leaning against an obstacle, thus preventing a joint to rotate in both directions. This slight rotation is part of the homing procedure, which is necessary only during the first activation of the robot (after a power-up). That said, in such a scenario, always try to use the recovery mode first, which does not require homing. This would avoid having to disable the brakes.

If you do need to disable the brakes, with a safety feature like a light curtain installed to prevent entry into the robot's safety zone without triggering the P-Stop 1 (as in [Figure 3](#)), disengaging the robot's brakes while manually holding the robot becomes impossible. To proceed, you would need to temporarily swap your current D-Sub connection with our D-Sub dongle.



If your hands are penetrating the working zone of the Meca500, keep your fingers away from the pinch points of the robot. The procedure for disengaging the brakes of the robot while holding the robot does not meet the requirements of ISO 10218-1:2011.

Once you can approach the robot without triggering a P-Stop 1 event, turn on the power and ensure that the E-Stop on the power supply is not pressed. Next, to minimize the risks that a remote commands activates the robot, unplug the Ethernet cable controlling the robot. Then, while the robot is still deactivated, press one of the two 0G buttons on the base of the robot continuously while holding the robot with your other hand. After 3 seconds, you will hear the deactivation of the brakes. Continue holding the 0G button pressed and move the robot links away from obstacles. Finally, release the 0G button, and move away from the robot.



Note that in the case of a collision, the robot is not deactivated and you can easily reset the motion error and jog the robot away, without entering the safety enclosure of the robot. If you are worried about damaging your equipment, it is advisable to first enter recovery mode (as described in the [Programming Manual](#)).

2.3.3 Stopping times and distances

As already mention, in the Meca500, when an E-Stop is applied, the power supply sends a signal to the robot to decelerate to a complete stop and after 450 ms removes power from the robot (R3) or from the motors (R4). Once, power is removed from the motors, the brakes are automatically applied.

[Table 2](#) shows values for the worst possible scenario, where the stop signal from the power supply is not detected by the robot. These are only theoretical values, because applying the brakes without decelerating the robot will permanently damage the robot. The actual values will be slightly larger due to the slip of the brake pads.



Note that only the E-Stop functionality is designed to achieve PL=d. Therefore, we cannot guarantee that the robot will immediately detect the signal from the power supply.

Table 2: Stopping distances and times at 100% speed for worst case scenario (the robot will be damaged)

Joint	Stopping distance	Stop time
1	67°	0.450 s
2	67°	0.450 s
3	81°	0.450 s

In normal, fault-free operation, the stopping times and distances for an E-Stop (category 1) at 100% speed and payload are presented in Table 3. All test results are for a single joint moving at a time, while the other joints are positioned in a way that the arm is fully stretched (i.e. worst condition). The results are valid only for an installation where the axis of joint 1 is parallel to the direction of gravity.

Table 3: Stopping distances and times for fault-free operation

Joint	Stopping distance	Stop time
1	6.2°	0.104 s
2	6.2°	0.125 s
3	8.1°	0.129 s

2.3.4 Joint limits

Because of the robot's compact dimensions, mechanical means to limit joint range have not been incorporated. It is possible to design a fixture that can be attached to the robot's base and that limits mechanically the range of joint 1. However, remember to not modify the robot itself (e.g., by removing screws from the robot).

The robot's joint limits can be reduced by software means using the MecaPortal or the command `SetJointLimits`. The new software limits remain active even after power shutdown. However, they will be reset to the default values, if a factory reset is performed on the robot. These software limits are not safety rated.

2.3.5 Joint torque limits

Once a robot is activated and homed, you can also reduce the joint torque limits using the command `SetTorqueLimits`. However, the joint torque limits are reset to 100% every time, the robot is reactivated. Furthermore, these joint torque limits are not safety rated.

2.3.6 Loss of Ethernet connection

When using the MecaPortal web interface or any other TCP/IP client, as soon as the robot detects a loss in the connection while moving, it will stop within 0.1 s. To prevent delays due to the use of Ethernet switches, at all times (not only while the robot is moving), use the `ConnectionWatchdog` command (available since firmware 10.1).

3. TECHNICAL SPECIFICATIONS

Table 4 lists the main technical specifications of the Meca500 robot arm.

Table 4: Technical specifications for the Meca500 (R3 and R4)

TECHNICAL SPECIFICATIONS FOR ROBOT ARM	
Characteristic	Value
Position repeatability	0.005 mm
Rated payload	0.5 kg
Maximum payload	1.0 kg (under special conditions)
Weight (without the cables)	4.6 kg
Mounting orientations	any angle
Range for joint 1	[-175°, 175°]
Range for joint 2	[-70°, 90°]
Range for joint 3	[-135°, 70°]
Range for joint 4	[-170°, 170°]
Range for joint 5	[-115°, 115°]
Range for joint 6	[-36,000°, 36,000°]
Maximum speed for joints 1 & 2 (R3 R4)	150°/s 225°/s
Maximum speed for joint 3 (R3 R4)	180°/s 225°/s
Maximum speed for joints 4 & 5 (R3 R4)	300°/s 350°/s
Maximum speed for joint 6 (R3 R4)	500°/s 500°/s
Maximum acceleration torque for joints 1, 2, 3 (R3 R4)	16.6 Nm 16.6 Nm
Maximum acceleration torque for joints 4 & 5 (R3 R4)	2.5 Nm 2.5 Nm
Maximum acceleration torque for joint 6 (R3 R4)	1.5 Nm 1.5 Nm
Maximum continuous torque for each joint	50% of the acceleration torque value
Input voltage	24 V (DC)
Maximum input current	5.5 A
Operating ambient temperature range	[5°C, 35°C]
Operating ambient relative humidity range	[10%, 80%] (non-condensing)
Airborne noise level	50dB (only when the robot is moving fast; when it is immobile, the noise is barely perceptible)
Maximum operating altitude	2000 m
Cleanroom classification	ISO Class 6
Robot body material	Anodized aluminum alloy
IP rating	IP 40

Figure 9 shows all the link lengths and offsets of the Meca500, necessary for obtaining the so-called Denavit-Hartenberg parameters. Note that all joints are at zero degrees in the configuration drawn in black line. Also note that the gray zone is the area attainable by the center of the robot's wrist center (the intersection point of the last three axes), for a fixed angle of joint 1. This area, or even the volume obtained by sweeping this area about the axis of joint 1 is NOT the workspace of the robot. The workspace of the robot is a six-dimensional entity depending on the definition of the tool reference frame. The workspace is the set of all attainable poses (positions and orientations) of the tool reference frame with respect to the robot's base. Even for a specific choice of a tool reference frame, it is impossible to represent this six-dimensional workspace (read [this tutorial](#) of ours).

Similarly, while the maximum tool-center point (TCP) speed is software limited to 5,000 mm/s when the robot executes Cartesian-space motion commands, it makes little sense to specify here the actual maximum attainable TCP speed. Indeed, the actual maximum TCP speed is highly dependent on the robot joint position and, of course, on the TCP definition. For example, for a TCP that is located some 50 mm away from the robot's flange, along the axis of joint 6, the maximum attainable TCP speed is approximately 3500 mm/s for the Meca500 R4, when the robot is fully stretched and all joints rotate at full speed. However, in most situations, the maximum TCP speed will be much lower.

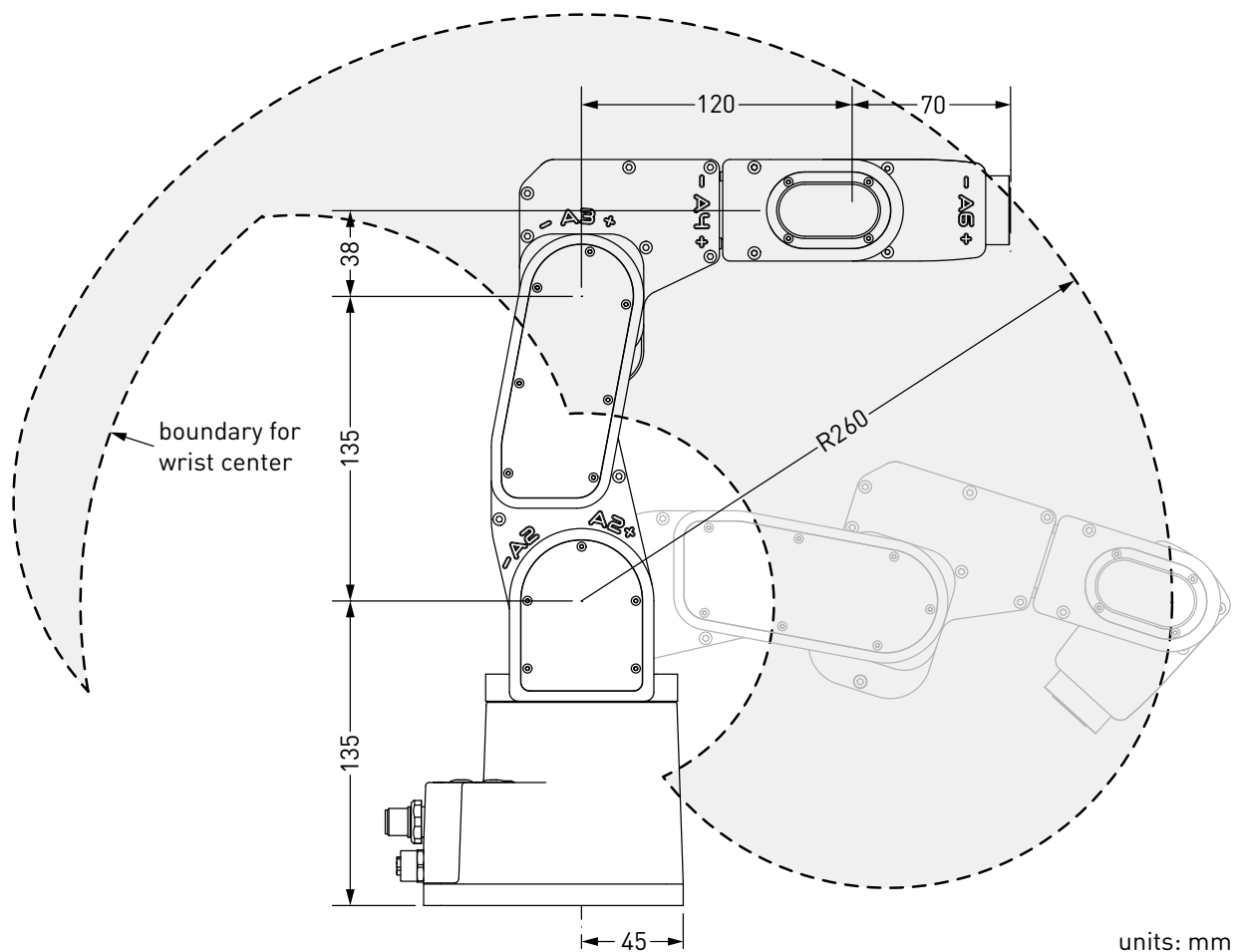

Figure 9: The dimensions of the Meca500 (R3 and R4)

Table 5 lists the technical specifications of the PS200 power supply that comes with the Meca500.

Table 5: Technical specifications for the PS200 power supply (R3 and R4)

TECHNICAL SPECIFICATIONS FOR PS200 POWER SUPPLY	
Characteristic	Value
Weight	0.7 kg
Mounting orientations	any angle
Input voltage range	[90 V, 250 V], AC, single phase
Input frequency range	[50 Hz, 60 Hz]
Maximum input current	4 A
Input power connector	IEC C14
Power factor	0.95
Maximum power output	132 W at 5% duty cycle
Maximum measured leakage current	0.047 mA
System grounding type	TN
Operating ambient temperature range	[5°C, 35°C]
Operating ambient relative humidity range	[10%, 80%] (non-condensing)
Maximum operating altitude	2000 m
Robot body material	Anodized aluminum alloy
IP rating	IP40

Table 6: Technical specifications for the safety I/O interface on the power supply of R3

TECHNICAL SPECIFICATIONS FOR SAFETY I/O INTERFACE ON R3				
Parameter	Min.	Typical	Max.	Unit
Safety input voltage	5	–	24	V
Safety input current	–	24	24	mA
Power status output voltage	0	–	24	V
Power status output current	0	–	60	mA

Table 7: Technical specifications for the safety I/O interface on the power supply of R4

TECHNICAL SPECIFICATIONS FOR SAFETY I/O INTERFACE ON R4				
Parameter	Min.	Typical	Max.	Unit
Safety input voltage	5	–	24	V
Safety input current	–	–	10 [†]	mA
Power status output voltage	0	–	24	V
Power status output current	0	–	60	mA

[†]Current is internally limited to 10mA

[Table 5](#) lists the technical specifications for the power supply for both R3 and R4 revisions of the Meca500. As already mentioned, the power supply provided has an IEC C14 connector that accepts an AC power cord with three-prong IEC C13 connector on one end, and your own country's power plug on the other. You can connect this power cord to any AC source that supplies voltage between 90 V and 250 V at frequency between 50 Hz to 60 Hz. We also recommend that you use a surge protector, such as the ASCO Model 241 from Schneider Electric.



We recommend that you use a surge protector when connecting the power supply to an AC power source.

[Table 6](#) and [Table 7](#) list the requirements for the I/O connections on the power supply in the case of the Meca500 R3 and R4, respectively. Further details will be provided in [Section 7](#).

Finally, the CAD files of the Meca500 robot arm and of its power supply (in STEP format) can be downloaded from our [web site](#). You can also use one of several robot simulation and offline programming software packages that include a model of our Meca500, including Visual Components and RoboDK. Note that we also offer a [Mecademic-only version of RoboDK](#), for exclusive use with our robots.

4. INSTALLING THE ROBOT SYSTEM

Before operating your Meca500, you must fix solidly its base with four M6 screws, at 3 Nm, with at least 6 mm of thread engagement. We typically use metric breadboards such as those from Thorlabs, but you can also use our adaptor plate (MUAP01), build your entire robot cell at Vention, or use the modular system made by Tessella Automation. We recommend that you use three kinematic positioners to constraint your base, so that you can always remove and then install it in the exact same location. Our adaptor plate, for example, incorporates three locating pins.

The dimensions of the robot base are shown in Figure 10 and an example of installation is shown in Figure 11. Note that you can install the robot base in any orientation. The robot will automatically detect the angle between the axis of joint 1 and the gravity vector (no need to manually specify this angle). Also, note that you can mount the robot's base on a mobile body (e.g., on the carriage of a linear guide), but only if you do not intend to move the robot's joints, while the robot's base is accelerating with respect to the ground.

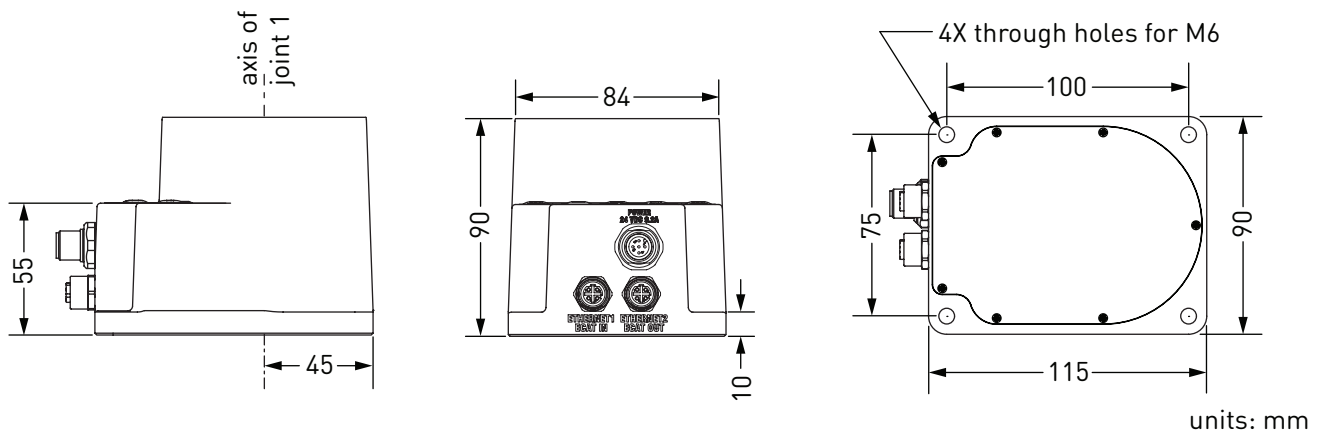

Figure 10: Dimensions of the robot base

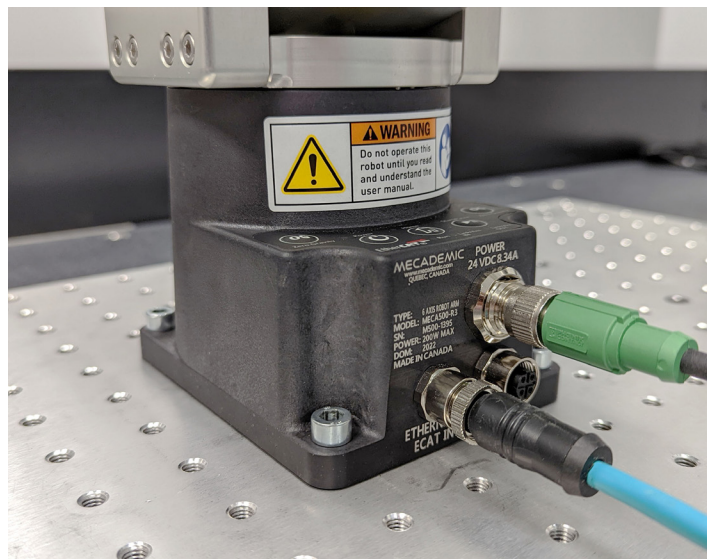

Figure 11: The robot base installed, with the connectors attached

Do not install any end-effector yet. We will cover this topic in [Section 8](#).

Next, you must solidly attach the smart power supply using four M6 screws ([Figure 12](#)), at a location sufficiently close to the robot's base to allow connection with the 2-meter DC cable provided, but outside the robot's safety enclosure. Unless you are using an external emergency stop wired via the D-Sub connector, you must fix the power supply at a location that makes the integrated E-STOP button readily accessible by an operator.

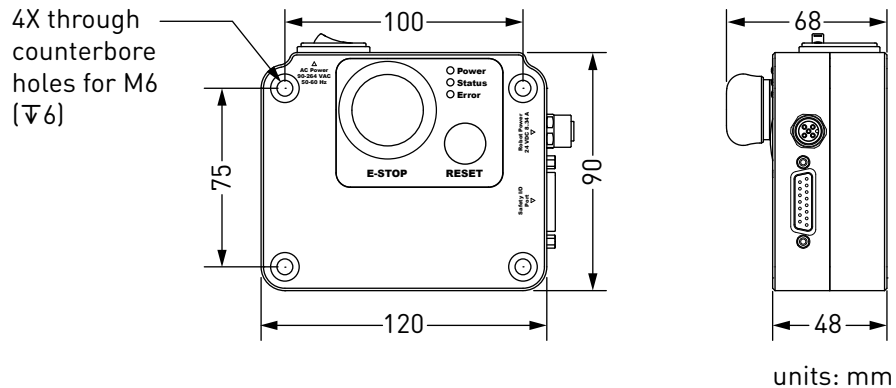

Figure 12: Dimensions of the PS200 smart power supply

Next, attach the circular connector of the Ethernet cable to the ETHERNET1 port on the robot's base and connect the RJ-45 jack to your computer or router ([Figure 11](#)). The two Ethernet ports on the robot base act as a bridge, so you can daisy-chain several Meca500 robots, or connect an Ethernet I/O module on the ETHERNET2 port.

Finally, use the DC power cable provided to connect the unpowered power supply to the robot's DC power connector ([Figure 11](#)). Make sure the connectors are completely screwed, or else you may damage the robot. Then, connect the power supply to your country-specific AC power cord (not provided).



Always connect the DC power cable before connecting the power supply to an AC outlet. Always disconnect the power supply from the AC outlet before disconnecting the DC power cable.

5. OPERATING THE ROBOT

This section presents the basic procedures for setting up and operating the Meca500. For further details, refer to [Section 6](#), which describes the web interface of the robot, and the [Programming Manual](#).

5.1. First-time use

5.1.1 D-Sub dongle (first time use and maintenance only)

Connect the D-Sub dongle to the power supply D-Sub interface. This would deactivate the external protective stop and emergency stop connections.



Connect the D-Sub dongle to the power supply interface, while the power supply is still switched off. NEVER CONNECT OR UNPLUG THE DONGLE WHILE THE POWER SUPPLY IS ON.



The D-Sub dongle is a bypass device to be used during setup and maintenance only. You must wire the appropriate safety I/O connections when using the robot in production mode (see [Section 7](#)).



Stand away from the robot when it is activated, wear safety goggles and close-fitting clothing, keep long hair securely tied back and be attentive and alert. In case of an emergency, press the E-STOP button (on the power supply) immediately.

5.1.2 Configuring your Ethernet connection (first time use)

Configure your computer Ethernet connection with a static IP address, on the same subnet as the robot's default IP address, i.e., 192.168.0.x. The way to do this differs from one operating system to another. [Figure 13](#) shows how to do this in Windows and in Linux.

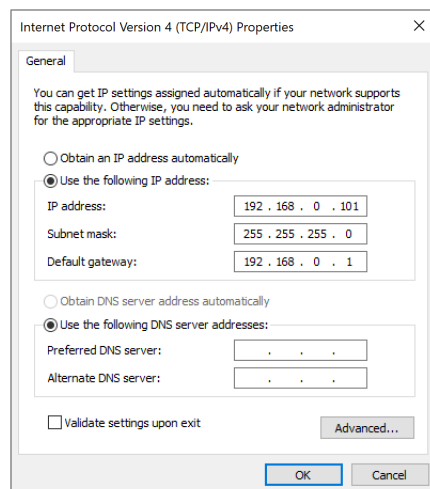

(a) Windows

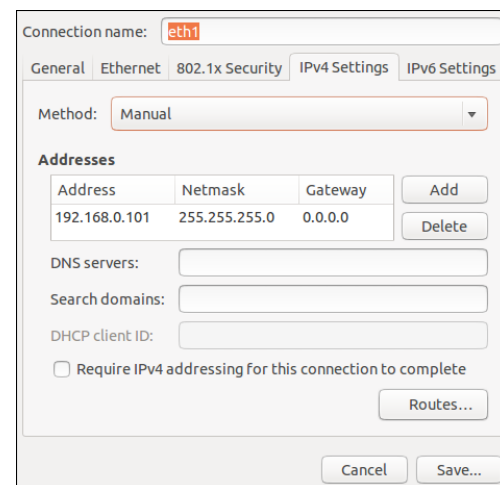

(b) Linux

Figure 13: Two examples of how to configure the IP address of your computer

5.2. Power-up procedure

5.2.1 Powering the robot

1. Turn on the power supply. The green LED on the power supply (next to "Power") will be illuminated.
2. Make sure the E-STOP button is disengaged by twisting it counter-clockwise.
3. In the case of Meca500 R3, press the RESET button to provide power to the robot.
4. You will hear a clicking sound coming from the power supply, and the robot's LEDs will start flashing for a few seconds while the robot's controller is booting. Once the controller ready, the red LED on the robot's base will start flashing intermittently. Note that the color of this LED does not meet the requirements of IEEC 60204-1.
5. Depending on which of the two Ethernet ports was used in step 1, the Link/Act IN (for ETHERNET1) or Link/Act OUT (for ETHERNET2) green LED will stop flashing and remain illuminated, but only once the robot has finished booting.
6. In the case of the Meca500 R4, press the RESET button to provide power to the robot's motors.

5.2.2 Connecting to the robot

1. Open (preferably) the latest version of Google Chrome and type Meca500's default IP address 192.168.0.100 in the address bar.
2. Meca500's web interface, called MecaPortal, should load instantaneously (Figure 14). The MecaPortal will be described in detail in [Section 6](#).

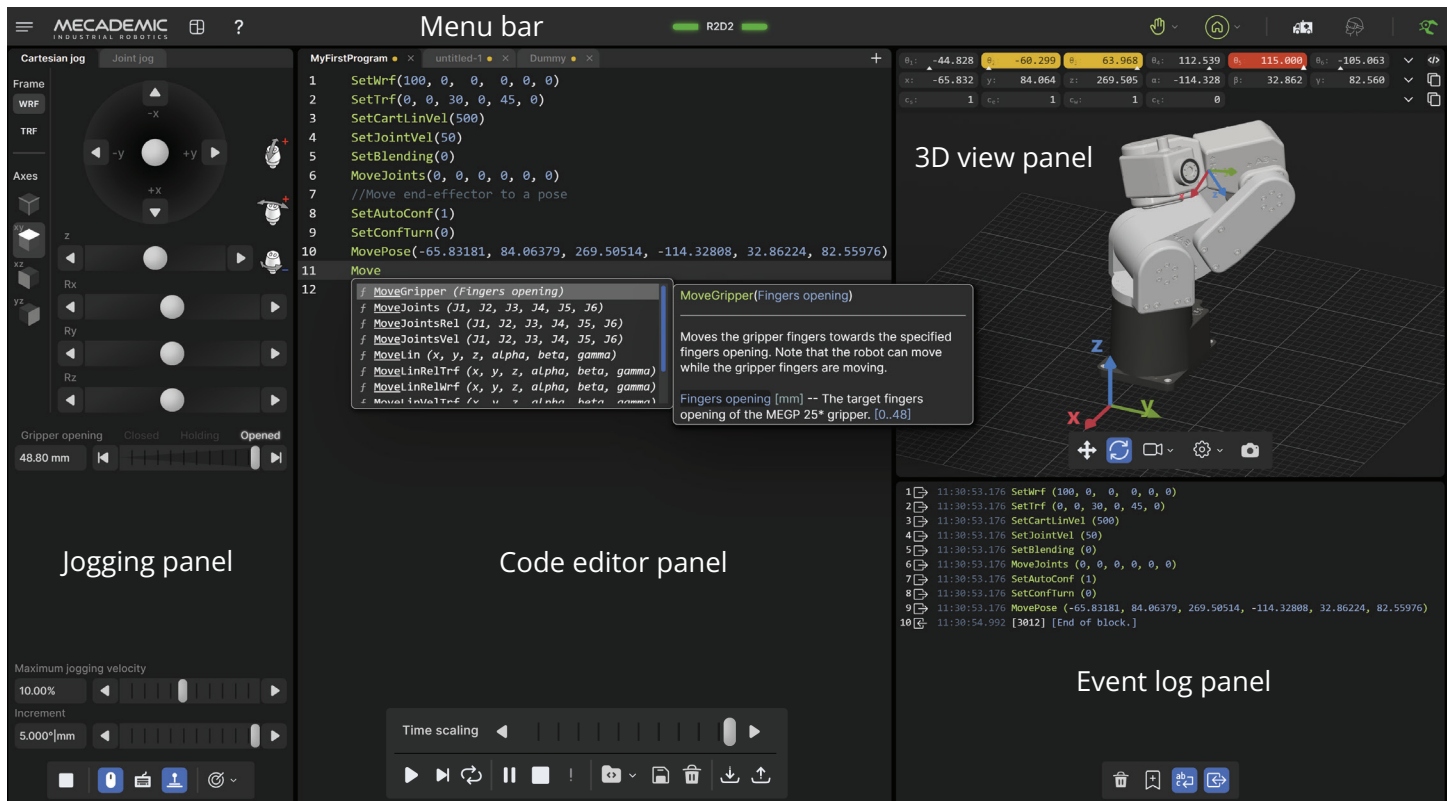



Figure 14: Overview of the MecaPortal

5.2.3 Changing the robot's network configuration (optional)

1. Click on the connection state button on the top right of the MecaPortal and select  "Control" (see [Figure 15](#)).
2. Click on the configuration menu button, , in the top left corner of the MecaPortal and select "Network configuration".
3. Depending on your configuration, activate the toggle DHCP to automatically receive an address from your router or leave untoggled to force a specific IP. You don't need to reboot the robot; the new configuration will be applied as soon as you click on the Apply button ([Figure 16](#)).

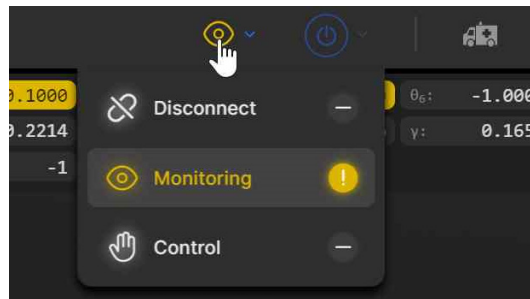

Figure 15: Connection state button

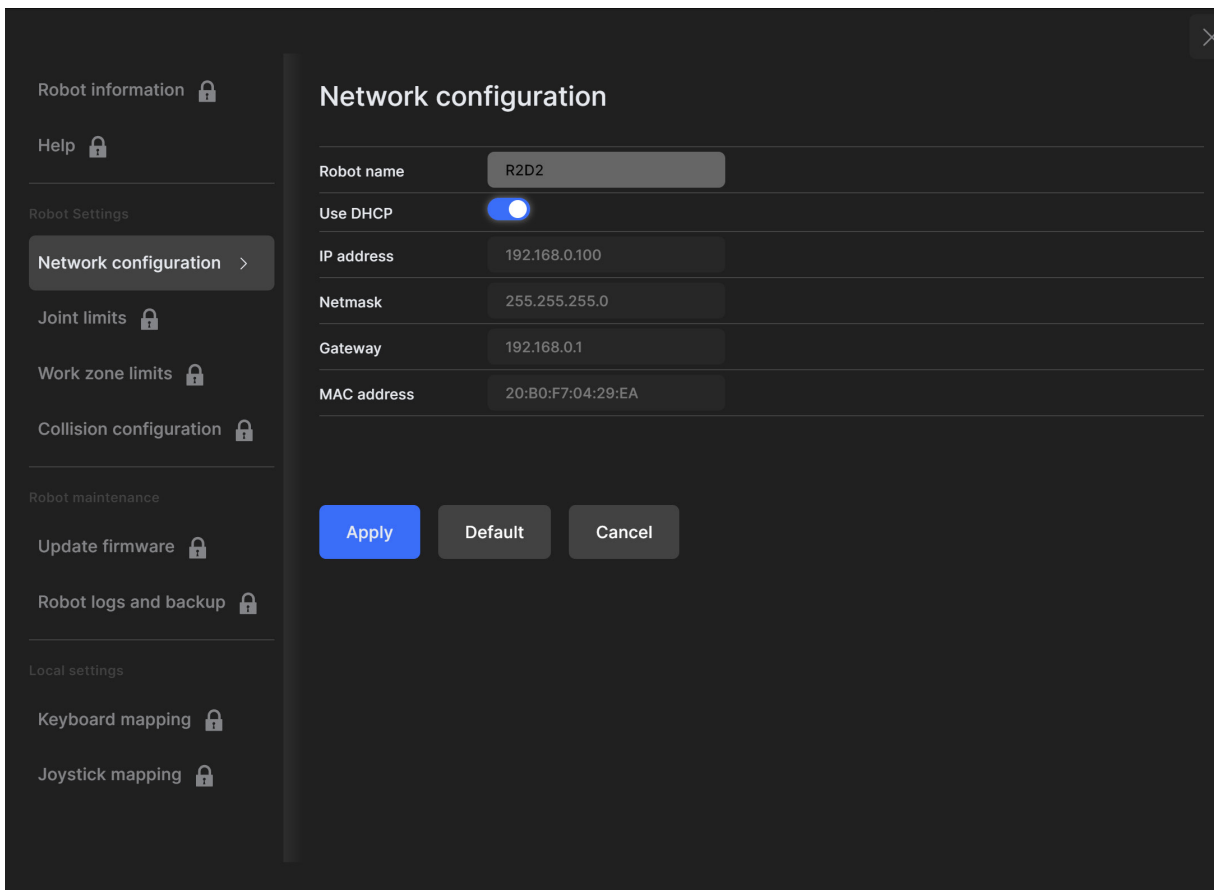



Figure 16: Changing the robot's network configuration

5.2.4 Activating and homing the robot

Click the  button in the menu bar and select  "Activate then Home".



The robot will move slightly during homing. Before homing it, make sure that there is no risk for mechanical interference.

5.2.5 Testing joint 6

After homing, type "0" in the text field next to θ_6 (joint 6) in the Jog joint tab and press Enter. The flange of the robot must be exactly as in [Figure 17](#). Later, when you connect tooling to the flange of the robot, you must remember the correct orientation of the tooling when joint 6 is at zero degrees, and continue to perform this test every time you start your robot.

If the flange is rotated $\pm 120^\circ$ with respect to the orientation shown in [Figure 17](#), perform the procedure given below, before continuing to use the robot.



The range of the absolute encoder of joint 6 is only $\pm 420^\circ$. Therefore, you must always rotate joint 6 within that range before switching the robot off. Failure to do so may lead to an offset of $\pm 120^\circ$ in joint 6. If this happens, unpower the robot and disconnect your tooling. Then, power up and activate the robot, perform its homing, and zero joint 6. If the screw on the robot's flange is not as in [Figure 17](#), then rotate joint 6 to $+720^\circ$, and deactivate the robot. Next, reactivate it with the command `ActivateRobot(1)`, which reinitializes the drives, then home the robot, and zero joint 6 again. Repeat one more time if the problem is not solved.



Figure 17: Joint 6 at zero degrees

5.2.6 Moving the robot

A six-axis robot arm is a complex mechanism and no matter how intuitive its programming interface is, the robot will still have limits. These limitations are not always obvious. For example, in any six-axis robot arm, there are often paths that the robot cannot follow, even though they seem to be inside the robot's workspace. The workspace of a typical six-axis robot is a very intricate six-dimensional entity.



If you know nothing about orientation representations and robot singularities, we strongly advise you to read some introductory notes on robotics and our tutorials on [Euler angles](#) and on [robot singularities](#).

After homing, click the  button in the jogging panel and select "Zero all joints". The robot will move all of its joints to their 0° positions. In this robot joint set (shown in [Figure 9](#)), the robot is in a so-called wrist singularity. Most industrial robots cannot move in Cartesian mode from such a singularity. In order to simplify the use of the Meca500, as of firmware 9, we have implemented an algorithm that allows the robot to move through such a singularity.



The Cartesian coordinates displayed above the robot in the web interface are those of the Tool Reference Frame (TRF) with respect to the World Reference Frame (WRF). Both frames are displayed in the web interface. By default, the TRF is located at the flange of the robot and the WRF at the bottom of the robot's base (as in [Figure 23](#)). The origin of the TRF is called the TCP (Tool Center Point).



We use Euler angles (α , β , γ) to define the orientation of a second reference frame with respect to a first one. More specifically, if we consider both frames initially coincident, we rotate the second frame about its x axis at α degrees, then about its y axis at β degrees, and finally about its z axis at γ degrees. This Euler-angle convention is sometimes referred to as XY'Z''.

Thus, for example, you can simply go to the Cartesian tab of the jogging menu, and with the TRF option selected, press the right arrow button of the x jogging bar. Alternatively, you can perform the same kind of linear motion by following any of these steps:

- Clear the programming text field, type `MoveLin(250,0,150,0,90,0)`, and press .

OR

- Clear the programming text field, type `MoveLinRe1TRF(58,0,0,0,0,0)`, and press .

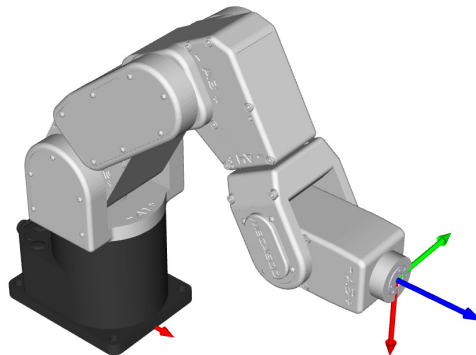

Figure 18: Robot position when the TRF is at $x = 250$ mm, $y = 0$ mm, $z = 150$ mm, $\alpha = 0^\circ$, $\beta = 90^\circ$, $\gamma = 0^\circ$ with respect to the WRF

[Figure 18](#) shows the resulting robot position.

5.2.7 Testing the E-STOP button and the brakes (first time use)

Execute a movement command and, while the robot is still moving, press the E-STOP button on the smart power supply. The power supply completely cuts power to the robot, in the case of R3 version, or only to the robot motors and Mecaademic's EOAT, in the case of R4 version. In both cases, the robot brakes will be automatically applied to joints 1, 2 and 3. If joints 1, 2 or 3 continue to move, or if you notice that the even after powering off the robot, one or more of these joints can be as easily rotated by

hand as joints 4, 5 and 6, cease using the robot immediately and contact us immediately.

To use the robot again, you must power on the robot, release the E-STOP button by twisting it clockwise, press the RESET button, then activate and home the robot.

5.3. Power-off procedure

5.3.1 Zeroing the robot joints

It might be a good idea to always bring the robot joints to their zero positions before turning the robot off. This can be done in two ways:

- send a `MoveJoints` command with all arguments equal to 0



OR

- click the  button in the jogging panel and select "Zero all joints".

If you cannot zero all joints, you must at least bring joint 6 inside the range $\pm 420^\circ$ before switching the robot off. (recall [Section 5.2.5](#))

5.3.2 Deactivating the robot

To deactivate the robot

- clear the  button and then select  "Deactivate"

OR

- send the `DeactivateRobot` command via the programming editor.



Recall that there are no brakes on joints 4, 5 and 6. As soon as you deactivate the robot, the end-effector will slowly tilt down under the effects of gravity.



If you accidentally close your web interface before deactivating the robot, the robot will stop (in case it was moving) but will remain activated.

5.3.3 Disconnecting the robot

To disconnect the web interface from the robot, select the  option from the connection state group.



If you disconnect the web interface from the robot before deactivating the robot, the robot will stop moving.

5.3.4 Removing power

Finally, unplug the power supply from the AC outlet or switch the power supply off.



Never detach the DC power connector from the robot's base, before unplugging the power supply's AC power cord from the AC outlet or switching the power supply off.

5.4. Robot control panel

The set of buttons and LEDs on the robot's base is called the robot's control panel (Figure 19). The meanings of the LEDs and the functionalities of the buttons will be summarized in what follows.

Note that these buttons and LEDs are intended mainly for development and demonstration purposes, as they will not be physically accessible and possibly not visible during a normal operation of the robot, where the robot is fenced. The information conveyed from these LEDs and the actions controlled by these buttons are all available in the MecaPortal. The only exceptions are the Link/Act LEDs and the Run LED. The information conveyed by the Run LED, used only when the robot is controlled via EtherCAT, is accessible by the EtherCAT master.



Figure 19: Robot control panel

5.4.1 Buttons

When the robot is powered and deactivated, the 0G button is active but the other buttons are active only when no user is connected to the robot. In what follows, you must refer to the detailed descriptions of the commands associated with each button.



When pressing the buttons on the robot's base, keep your fingers away from the pinch points of the robot, and move away from the robot as soon as a button is released. These buttons are for development purposes only. They do not meet the requirements of ISO 10218-1:2011.

Power button

The Power button acts as the `ActivateRobot` and `DeactivateRobot` commands:

- when the robot is deactivated, pressing Power will send the `ActivateRobot` command.
- when the robot is activated, pressing Power will send the `DeactivateRobot` command.
- when the robot is in error mode, pressing and holding Power for five seconds will send the `DeactivateRobot` command.

Pressing and holding Power during power-up will reset the robot network configuration.

Home button

The Home button acts as the `Home` and `ResetError` commands:

- when the robot is deactivated, pressing Home has no effect.
- when the robot is activated, pressing Home sends the `Home` command.
- when the robot is homed, pressing Home has no effect.
- when the robot is in error mode, pressing and holding Home for five seconds will send the `ResetError` command.

Start/Pause button

The Start/Pause button on the robot control panel acts as the `StartProgram`, `PauseMotion`, `ResumeMotion`, and `ClearMotion` commands:

- when the robot is activated, homed and not executing a program, pressing Start/Pause will send the `StartProgram(1)` command three seconds after being pressed.
- when the robot is activated and homed, pressing Start/Pause will send the `ClearMotion` command, whether the robot is moving or not.
- when the robot is activated, homed and moving, pressing Start/Pause will send the `PauseMotion` command.
- when the robot is activated, homed and stopped (by the `PauseMotion` command), pressing Start/Pause will send the `ResumeMotion` command.

0G button

Pressing and holding any of the two 0G buttons for three seconds, but only if the robot is deactivated, will release the brakes. While keeping 0G pressed with one hand, you can manually move the robot with your other hand. The brakes will re-engage as soon as the 0G button is released.



Once the robot is deactivated, hold the robot with one hand, before pressing the 0G button. Otherwise, the robot may fall down under the effect of gravity.

5.4.2 LEDs

After a power up, the Power, Home and Start/Pause LEDs will flash fast simultaneously during a couple of seconds. After that, the LEDs will be lit as described below.

Power LED

The Power LED is red and indicates the activation state of the robot:

- The LED will flash slowly when the robot is deactivated.
- The LED will flash fast when the robot is being activated.
- The LED will be lit continuously when the robot is activated.



Note that the color of the Power LED does not meet the requirements of IEC 60204-1.

Home LED

The Home LED is yellow and indicates the homing state of the robot:

- The LED will be off when the robot is not homed.
- The LED will flash slowly when the robot is being homed.
- The LED will be lit continuously when the robot is homed.

Start/Pause LED

The Start/Pause LED is yellow and indicates the motion state of the robot:

- The LED will flash fast when the Start/Pause button was pressed and the program saved in the robot is about to start.
- The LED will be off when the robot is not moving.
- The LED will be lit continuously when the robot is moving.

Link/Act IN and Link/Act Out LEDs

Both LEDs are green and flash when there is network activity in the corresponding Ethernet port. The LEDs function in the same manner as on a normal Ethernet RJ-45 port.

Run LED



Used only when the robot is controlled via EtherCAT (see the Programming Manual).

Finally, when the robot is in error mode, the Power, Home and Start/Pause LEDs flash fast simultaneously. Also, if you keep the Power button pressed continuously during power-up, which provokes a network reset of the robot, the Power, Home and Play LEDs, will first flash simultaneously eleven times, and then blink several times sequentially.

5.5. Offline mode (for demonstrations only)

You can store an offline program in the robot and execute it without an external computer. This program is kept, even after power off, until replaced by another one. You can save up to 500 programs, but only the first one can be executed from the robot control panel.

5.5.1 Saving the program via the web interface

- To save a program via the buttons on the web interface, the robot must be deactivated.
- Write the program in the programming editor.
- To run the program on infinite loop, insert the command `SetOfflineProgramLoop(1)`. (The  checkbox has no effect on the execution of the offline program.)
- Change the name of the program to "1" by double-clicking on the tab with the program.
- Click on the  button.

5.5.2 Running an offline program

To execute the offline program 1, make sure there is no user connected to the robot and press the Start/Pause button on the robot base. The Start/Pause LED will flash rapidly for three seconds, after which the robot will start executing the program.



Immediately after pressing the Start/Pause button on the robot's base, move away your hand and stay outside the robot's reach.

It is highly recommended to run offline programs using any of the communication protocols, rather than by using the button on the robot control panel, which not only presents certain safety risks but can only execute program 1.

6. THE MECAPORTAL

Meca500's web interface, called MecaPortal, is more or less the equivalent of the teach pendant's interface of a traditional industrial robot. The interface is essentially an HTML 5 web page with JavaScript and WebGL scripts. All of these files reside in the robot's controller, so you do not need to install anything on your computer, but Google Chrome.

The interface basically translates your mouse clicks, joystick movements and keyboard entries into proprietary commands that are sent to the robot's controller. These are primarily the same commands described in the Programming Manual that you will eventually start sending from your own application, written in C++, Java, Python or any other modern programming language. In addition, the web interface displays the feedback messages received from the robot and the 3D model of the actual robot.

The MecaPortal is intended mainly for testing and writing simple programs. You must create your own software application or program if you intend to use the robot for complex tasks, such as interacting with inputs and outputs (in which case you also need a third-party I/O module).

The web interface is also used for updating the firmware of your robot.

The MecaPortal, introduced in firmware 9.3, is a major upgrade of the previous web interface, in terms of aesthetics, usability and functionality. It is, however, possible to use the old web interface, but that interface will no longer be supported. You can access the legacy web portal from the configuration menu button, section "Help".

6.1. Updating the robot's firmware

Make sure that you have the latest firmware installed on the robot and that you read the manuals corresponding to that firmware. Go to the [Downloads](#) section of our web site and download the latest firmware (a zip file). Unzip it. Then, once you have followed the procedures of [Section 4](#), [Section 5.1](#), and [Section 5.2](#), and before activating the WebSocket/TCP connection and activating the robot, click on Update in the Options menu in the web interface. A new interface will load in the same browser tab. Click on Choose File and select the file Meca500*.update that you just extracted. Then click on the Upload button. Wait a couple of minutes for the update to be completed. Once completed, the robot will reboot and the new web interface will reload.

Now that you have installed the latest robot firmware, make sure to download the latest user and programming manuals from the [Downloads](#) section of our web site and keep these manuals until you update again your firmware.

Next time you update your robot's firmware, you must also read the PDF file that is in the zip package (i.e., the Release Notes). That document lists of all the recent firmware changes.



If you have the MEGP 25E or MEGP 25LS electric gripper or the MPM500 pneumatic module installed on your Meca500 during the robot's firmware update, the firmware of your end-of-arm-tooling (EOAT) will also be updated. Otherwise, you can update the firmware of your EOAT later, by following the same procedure but selecting the m500_exttools*.update file.

6.2. Overview













Figure 14 shows the main elements of the MecaPortal web interface. These are:

- The menu bar
- The code editor panel
- The jogging panel
- The 3D view panel
- The event log panel

You can show/hide each of the four panels from the button , in the menu bar.

6.3. The menu bar

From left to right, the menu bar features

- The configuration menu button, 
- The panels show/hide menu button, 
- The show/hide tooltips button, 
- The robot name surrounded by state bars (see Table 8)
- The connection state selector,  (disconnect) or  (monitoring) or  (control)
- The robot state selector,  (deactivate) or  (activate) or  (home)
- The recovery mode button, 
- The simulation mode button, 
- The end-of-arm tooling state icon, 



Until you get to know the MecaPortal, we recommend that you activate the tooltips using the button , in the menu bar. Most tooltips are disabled by default.

Table 8: The robot state bars in the MecaPortal

ROBOT STATE BARS	
Visual state	Explanation
Gray, solid	The robot is deactivated.
Yellow, solid	The robot is activated but not homed, or is in recovery mode but not moving.
Yellow, blinking	The robot is in recovery mode and executing motion commands.
Green, solid	The robot is homed.
Green, blinking	The robot is homed and executing motion commands.
Blue, solid	The robot motion is paused.
Red, blinking	The robot is in error mode.

6.3.1 The connection and robot state selectors

Normally, once the web user interface is loaded, you have not only established an HTTP connection with the robot, but also activated the socket messaging which is the only communication channel between the web interface and the robot. By default, the web interface connects to the robot in monitoring mode only (as seen in [Figure 15](#)). To control the robot click on the ☺ icon and select ☹. If the robot is in error when you connect to the robot, the connection state button will show a red blinking ▲ icon. You can still press that button and select to only monitor or control the robot. The monitoring option can be used to see in real-time the motion of the robot when another client (e.g., another MecaPortal, a Python program, or a Profinet application running on a PLC) is controlling the actual robot.

Next, you need to activate and home the robot by selecting the ☺ button. A list with three options will unroll. Click the ☺ icon to activate and home the robot. During homing, all joints rotate slightly for approximately 4 seconds. Make sure the robot is not near an obstacle.

6.4. The code editor panel

The code editor is used mainly for writing and executing simple programs, i.e., for testing. These programs are sequences of the proprietary commands described in the Programming Manual. The robot's command interface does not support conditionals, loops, or other flow control statements, nor variables. The robot only accepts request commands (to get data from the robot) and motion commands (to tell the robot how to move). The robot also supports comments in C/C++ style (e.g., // and /* */).

For complex tasks, you must write a program outside the web interface (e.g., in your preferred integrated development environment) that parses the robot's feedback, controls the robot, and handles all flow control logic. You can use any language that supports communication over TCP/IP (e.g., C/C++, C#, Python, Java or even Structured Text). Note that we offer a Python API on our [GitHub](#) account.

6.4.1 Using programs



You can create a new program using the + button in the upper right corner of the panel. The program name can be changed and the program saved to the robot's memory by either double-clicking on the program tab or by clicking the icon 📁 at the bottom of the code editor panel, which is equivalent to pressing the shortcut **Ctrl-Shift-s**. You can also save the program directly using the shortcut **Ctrl-s**.

Programs can be saved in different folders. To specify a folder, and simultaneously create it if it does not exist, simply type the name of the folder followed by a slash, immediately before the name of the program. You can specify multiple layers of folders. Naturally, the program names in a given folder must be unique, as well as the sub-folder names in a given folder.

Program and folder names are case sensitive and must contain a maximum of 63 characters among the 62 alphanumericals (A..Z, a..z, 0..9), the underscore and the hyphen.



A yellow dot to the right of the program's name indicates that the program has been changed and needs to be saved. If a syntax error is found in the code, during the saving, the yellow dot will turn red, and a red ▲ will appear in front of each line of code containing a syntax error. Note that the syntax validation is performed by the robot (and not by the MecaPortal) when the program is saved. Local changes won't be validated until the program is saved again.

The programs that appear in the code editor panel are simply those open in the MecaPortal and not necessarily in the robot's memory. The MecaPortal will locally save (in the browser's local storage) the

opened programs, whether or not they are saved on the robot. To open a program that is already in the robot's memory, click on the  icon. You can also delete programs from the same menu. Alternatively, you can delete a program that is open and in focus, by clicking the  icon. To simply close an open program, click the  on the tab with the program name.

A program can be called in another program with the StartProgram command, as in the following example: `StartProgram("my_folder/my_subfolder/program123")`.

To save and load programs from the robot, you must be connected to it in control mode, i.e., the connection state icon displayed in the menu bar must be .

You can also save the contents of the active code editor tab to your computer's Downloads folder by clicking the  icon. The file will be saved with the .mxprog extension. In addition, you can load a program from your computer, by clicking the  icon. Note that programs that are saved in sub-folders on the robot will have the slash character ("/") in their name replaced by a period character (".") in the file name on the PC. Similarly, if programs on your computer have a period in their name (excluding the period before the extension mxprog), the period character will be converted to a slash character and the program saved in a sub-folder on the robot.

6.4.2 Writing programs

The code editor provides syntax highlighting. In addition, once you start typing a command, a list of suggestions appears, allowing auto-completion. Furthermore, a brief description of the command appears, as shown in [Figure 14](#). Additionally, pressing the secondary mouse button when your mouse cursor is over the code editor text field brings a context menu with all available commands ([Figure 20](#)). The most important group is in "TO CURRENT POSITION" which inserts the selected command at the text cursor with the arguments corresponding to the current robot position, the current tool reference frame (TRF), and the current world reference frame (WRF). To cancel the context menu without inserting a command, press **Esc** or click away.

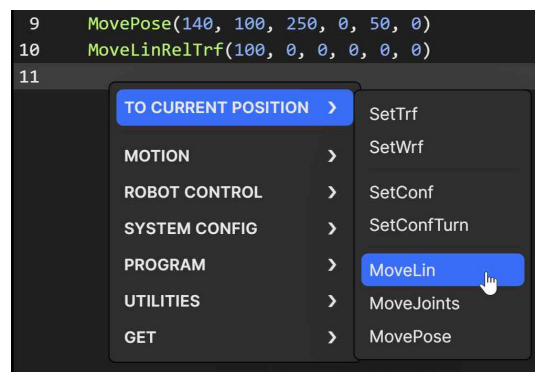

Figure 20: Context menu in the code editor

The code editor includes various editing features for productive source code editing. The shortcuts for accessing these features are presented in [Table 9](#). Note that you can select a block of text, a box of text (column select), or even have multiple cursors. Each line that has a text cursor or a selection of text becomes highlighted in gray and is called an *active line*. For example, in [Figure 20](#), line 11 is an active line.

Table 9: Shortcuts for source code editing

SHORTCUTS FOR SOURCE CODE EDITING	
Shortcut	Action
Ctrl+Space	Open the auto-complete popup menu
Ctrl+Shift+Space	Open the command help popup
Ctrl+a	Select all
Ctrl+d	Add selection to next find match
Ctrl+f	Open the find and replace dialog
Ctrl+g	Open the "go to line" dialog
Ctrl+/	Comment/uncomment active line(s)
Ctrl+Home	Move cursor to the beginning of the first line
Ctrl+End	Move cursor to the end of the last line
Ctrl+Right	Move cursor to next group
Ctrl+Left	Move cursor to previous group
Double click	Select group
Triple click	Select line
Alt+Up	Move active line(s) up
Alt+Down	Move active line(s) down
Shift+Alt+Up	Duplicate active line(s) and insert result above
Shift+Alt+Down	Duplicate active line(s) and insert result below
Alt+Click & drag	Select a box of text (column select)
Ctrl+Click	Place multiple cursors for simultaneous editing

6.4.3 Executing programs



You can execute the complete current program (even if it is not saved yet) by pressing the ► button at the bottom of the code editor panel. Alternatively, you can execute only the active line(s), by pressing the ► button, or by pressing **Ctrl+Enter**.

Once the robot starts executing motion commands, the ■ button will become highlighted in yellow, and the green status bars in the menu panel will start blinking. You can press that button (or **Alt+;**) at any time to stop the robot and clear its motion queue (i.e., to send the `ClearMotion` command to the robot). Alternatively, you can press the || button (or **Alt+.**) to pause the execution of motion commands (i.e., to send the `PauseMotion` command to the robot). To resume the execution of motion commands, press the || button again (which sends the `ResumeMotion` command).





At any time, if a motion error occurs (either while the robot is executing a command or is idle), the ! button will become red. Pressing that button, or clicking the "Reset error" link in the red popup that will appear, acknowledges and resets the error (i.e., the MecaPortal sends the `ResetError` command to the robot). Once the error was reset, you need to `ResumeMotion`, by clicking the || button (now blue).

Finally, recall that you can execute other programs, using the command `StartProgram`. With that command, you can only execute programs that have already been saved on the robot.

6.5. The event log panel





By default, the event log panel lists most commands sent to the robot, called *request messages*, AND most robot responses. Exceptions include the commands sent from the jogging panel, the configuration menu, and a few others. All messages are preceded with a time stamp and an integer number, starting from 1. Request messages are identified with the  icon, while robot responses are preceded with the  icon. The messages, which all start with a unique four-digit code enclosed in brackets, are explained in the Programming Manual.



The control buttons at the bottom of the event log panel are self-explanatory:

-  Clear the event log
-  Insert a text bookmark
-  Toggle the word wrapping
-  Toggle the listing of new request commands (robot responses are always listed)

Detailed robot logs can also be downloaded as a single text file from the configuration menu, .

6.6. The 3D view panel

The 3D view window shows a perspective projection of the robot in its current position, as well as the current *WRF (World Reference Frame)* and *TRF (Tool Reference Frame)*. To zoom in and out, place your mouse cursor over the 3D view window and use your mouse wheel. To change the view angle, press the primary mouse button (if the  button is highlighted) or the secondary mouse button (if the  button is highlighted) inside the 3D view window, hold it down and drag the mouse. To pan, press the primary mouse button (if the  button is highlighted) or the middle mouse button (if the  button is highlighted) inside the 3D view window, hold it down and drag the mouse. You can also select one of several preset views from the  menu.

Finally, you can show/hide the TRF, WRF, or the floor, and switch between perspective and orthographic projection from the  menu. You can also download a high-resolution screen capture of the current 3D view by pressing the  button.

6.6.1 The robot position display

As soon as the MecaPortal appears, the current robot position appears at the top of the 3D view panel. By default, we show:

- the six joint angles ($\theta_1, \theta_2, \theta_3, \theta_4, \theta_5, \theta_6$), in degrees,
- the position and orientation (in the XY'Z" Euler angle convention) of the TRF with respect to the WRF, in mm and degrees, respectively, and
- the robot configuration parameters.

One of the main limitations, when operating a robot, is its joint limits, which are different for each joint. We have therefore added various visual cues (patent pending), that represent the approximate joint position, relative to the corresponding joint limits. These cues are the up-pointing triangles under each joint position text field. The horizontal position of each triangle relative to the left and right limits of the corresponding text field, is proportional to the position of the corresponding joint relative to the joint limits. Furthermore, when the joint position is within 5 degrees of the joint limit, the corresponding text

field is highlighted in yellow, while if the joint limit is attained, the text field turns red. Similarly, when the angle of joint 3 is close to or equal to 72.429° (elbow singularity), or the angle of joint 5 is close to or equal to 0° (wrist singularity), the corresponding text field is highlighted in yellow. Finally, when the wrist center point is too close to or lies on the axis of joint 1 (shoulder singularity), the text fields of joints 2, 3, and 4 are highlighted in yellow. The Meca500 can cross singularities when moving with Cartesian-space commands, but the resulting motions are rarely optimal and should be avoided in production mode.



Another set of highly useful features can be accessed in the selection menus on the right of each of the three rows of data. You can select to either copy the data that is shown in the corresponding row by pressing the icon on the right (the icon is changed to ) or insert a specific command with arguments corresponding to the current robot position (the icon is changed to ). In addition, in the case of the first row of data, you can choose to show either the joints calculated or actual positions, the joints calculated or actual velocities, or even the joints torques. Similarly, in the case of the second row of data, you can choose to show either the calculated or actual pose of the TRF with respect to the WRF, or the calculated or actual Cartesian velocity of the TRF with respect to the WRF.

Table 10 shows the default keyboard shortcut for copying data from the robot position display or inserting instructions with that data at the current cursor in the code editor.

Table 10: Keyboard shortcuts related to current robot position and reference frame definitions

DEFAULT KEYBOARD SHORTCUTS RELATED TO CURRENT ROBOT POSITION	
Shortcut	Action
Alt+j	Insert MoveJoints command with current joint set as arguments
Alt+l	Insert MoveLin command with current TRF pose as arguments
Alt+p	Insert MovePose command with current TRF pose as arguments
Alt+c	Insert SetConf command with current posture configuration parameters as arguments
Alt+w	Insert SetWrf command with current WRF pose as arguments
Alt+t	Insert SetTrf command with current TRF pose as arguments
Alt+Shift+j	Copy current joint set
Alt+Shift+p	Copy current TRF pose with respect to the WRF
Alt+Shift+c	Copy the current posture configuration parameters
Alt+Shift+w	Copy the current definition of the WRF
Alt+Shift+t	Copy the current definition of the TRF

6.7. The jogging panel

The jogging panel is used to jog (move) the robot in several different ways (in the Cartesian or joint space) and with several different input devices (mouse, keyboard shortcuts or joystick). Once a desired robot joint arrangement is reached, you can use the context menu in the program editor field to insert a motion command with current joint set or TRF pose.

The jogging panel is enabled whenever the robot is ready to receive AND execute new motion commands. Every motion that can be commanded in the jogging panel can also be performed by sending commands from the code editor panel, though in a much less user-friendly manner. For safety reasons, when jogging, the robot can move only up to 50% of its maximum speed.

The jogging panel has two tabs that will be described in the following sections.

6.7.1 The joint jog tab

We use an innovative UI element (patent pending) for jogging each joint. That *jogging bar* is a mixture of a slider and a virtual single-axis joystick and has dual functionality, depending on which mouse button is used to interact with it (Figure 21). You can also jog each joint using keyboard shortcuts, as well as a three-axis or a six-axis joystick with at least two buttons. (Technically, you can use other joysticks, such as a PlayStation controller, but the icons displayed will be those for the SpaceMouse.)

By default, only the mouse is activated, and the button  at the bottom of the jogging panel is highlighted in blue. To jog each axis as if using a joystick, click the primary mouse button onto the thumb of the corresponding jogging bar and drag it right or left (Figure 21a). The further you drag the thumb away from its central position, right or left, the faster the joint turns, in positive or negative direction, respectively. In other words, you are directly controlling the joint speed, rather than the joint position. Alternatively, you can directly click with the primary mouse button on either of the two arrow buttons of the jogging bar and hold, which makes the joint rotate at the specified maximum jogging velocity.

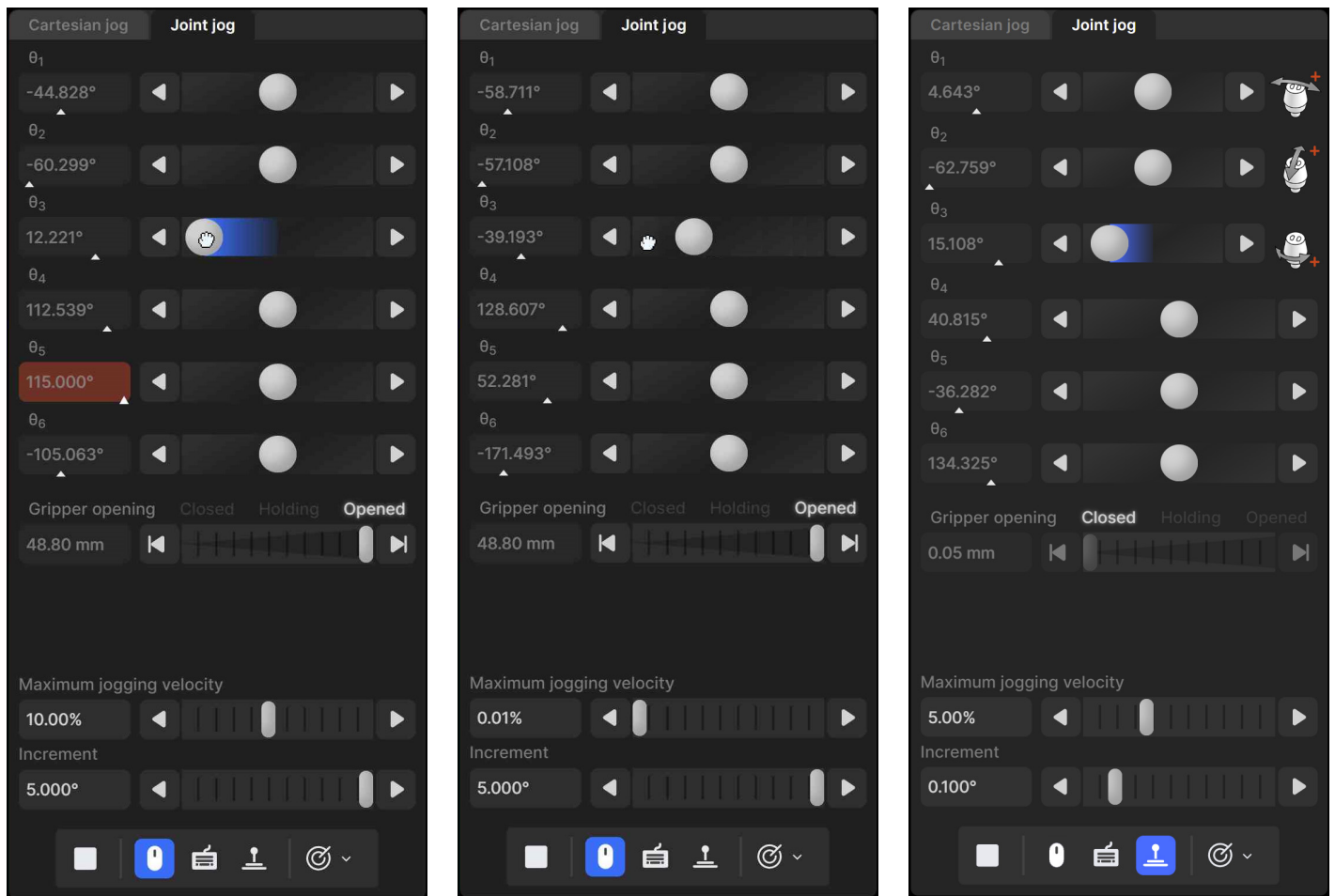

(a) Joint jogging using primary mouse button

(b) Joint jogging using secondary mouse button

(c) Joint jogging using Mecademic's three-axis joystick

Figure 21: Joint jog tab

You can also drag the thumbs of the jogging bars using the secondary mouse button (Figure 21b). Doing so, it is the mouse horizontal velocity (rather than relative position) that is mapped to the robot joint velocity. Additionally, clicking the left or right arrow buttons with the secondary mouse button commands a single incremental joint displacement, with the increment specified in the specified in the text field at the bottom of the jogging panel.

You can also directly specify the joint value by entering the joint angle in the text field next to each jogging bar. Note that each text field changes to yellow when the joint position is close to one of its limits or to a singularity (joints 3 and 5 only), or to red, when the joint position is at a limit or at a singularity, as is the case with the robot position display in the 3D view panel. In addition, the little triangle underneath each bar indicates the relative joint position with respect to the joint limits.





You can use keyboard shortcuts to jog the robot by activating the toggle button . Table 11 shows the default keyboard shortcuts for jogging the robot. The shortcuts are active only if the toggle button  is selected and the mouse cursor is over the jogging panel, in which case the panel is surrounded by a blue frame. You can change most of these shortcuts in the configuration menu, .

Table 11: Keyboard shortcuts for jogging (focus must be on jogging panel)

DEFAULT KEYBOARD SHORTCUTS FOR JOGGING	
Shortcut	Action
Shift+q* or q	Rotate joint 1 or move end-effector along x-axis, in negative direction
Shift+w* or w	Rotate joint 1 or move end-effector along x-axis, in positive direction
Shift+a* or a	Rotate joint 2 or move end-effector along y-axis, in negative direction
Shift+s* or s	Rotate joint 2 or move end-effector along y-axis, in positive direction
Shift+z* or z	Rotate joint 3 or move end-effector along z-axis, in negative direction
Shift+x* or x	Rotate joint 3 or move end-effector along z-axis, in positive direction
Shift+e* or e	Rotate joint 4 or rotate end-effector about x-axis, in negative direction
Shift+r* or r	Rotate joint 4 or rotate end-effector about x-axis, in positive direction
Shift+d* or d	Rotate joint 5 or rotate end-effector about y-axis, in negative direction
Shift+f* or f	Rotate joint 5 or rotate end-effector about y-axis, in positive direction
Shift+c* or c	Rotate joint 6 or rotate end-effector about z-axis, in negative direction
Shift+v* or v	Rotate joint 6 or rotate end-effector about z-axis, in positive direction
Shift+arrow* or arrow	Jog along each of the four directions chosen in the jogging pad
1	Open Cartesian jog panel and select TRF mode
2	Open Cartesian jog panel and select WRF mode
3	Open joint jog panel
.	Toggle between TRF and WRF mode, if Cartesian jog panel open
-	Reduce jog velocity
=	Increase jog velocity

* Hold Shift for continuous jog, otherwise robot will jog in increments.

Finally, you can jog the robot using either our MJ3 3-axis USB precision joystick (Figure 22a) or the SpaceMouse® 6-axis joystick from 3Dconnexion (Figure 22b). To use the MJ3 or the SpaceMouse, you

need to activate the button . For the MecaPortal to detect the joystick, you will need to press one of the device's buttons or, occasionally, unplug and replug the device. Once the joystick is detected you will see the respective joystick icons next to each slider ([Figure 21c](#)).



Contrary to the keyboard shortcuts for jogging the robot, the joystick is active even if the mouse cursor is not over the jogging menu, as long as the focus is on the MecaPortal.



Having multiple input modes for jogging activated simultaneously is unsafe. You should enable only one input mode at a time: the mouse, keyboard shortcuts, or the joystick.



Do not install the driver and the software that come with the SpaceMouse as these will interfere with the desired functioning of the device in the MecaPortal. Also, if you opt for the wireless model, keep the device close to the universal USB receiver and remember to recharge the device regularly.

You can deactivate certain joystick directions by clicking on the respective joystick icon, to the right of each slider bar. You can even customize the mapping between the joystick "axes" and the jogging directions in the configuration menu, .



(a) Mecademic's MJ3 3-axis precision joystick



(b) SpaceMouse® 6-axis joystick

Figure 22: USB joysticks that can be used with the MecaPortal

To select between joint jog, Cartesian jog with respect to the TRF or Cartesian jog with respect to the WRF, you can either use your mouse or press (up to two times if necessary) the right button of the SpaceMouse or of the MJ3 until the desired selection is obtained.

For much more precise jogging, we strongly recommend the use of our MJ3. In the case of the MJ3, the left button of the joystick toggles the assignments for the three axes.

Finally, in both the joint jog and Cartesian jog panels, there are sliders with text-fields for controlling your MEGP 25* gripper, the maximum jogging velocity, and the increment (for incremental jogging). You can also use the keyboard shortcut **Alt+G** to open/close the MEGP 25* gripper.

In addition, for convenience, the same stop button ■ available at the bottom of the code editor is also provided at the bottom of both jogging menus. Lastly, a list of predefined robot positions (essentially, joint sets) are stored and available in the 🎯 menu button. Clicking on one of these robot positions moves the robot to that joint set, in joint mode.

6.7.2 The Cartesian jog tab

In the Cartesian jog tab (Figure 23), you can move the robot along (labels X, Y, Z) or about (labels Rx, Ry, or Rz) the axes of the TRF (if the TRF button is selected, as in the figure) or along or about the axes of a reference frame having the same orientation as the WRF but with origin at the TCP (if WRF is selected).

As with the joint jog tab, the jogging bars can be controlled with both the primary (Figure 23a) and secondary (Figure 23b) mouse buttons, using the same logic. However, you can merge two jogging bars for linear movement (i.e., X and Y, Y and Z, or Z and X) into a *2D jogging pad* using the buttons under the label "Axes". Note that subsequent clicks on one of these buttons changes the jogging directions in the 2D jogging pad (there are a total of eight combinations).

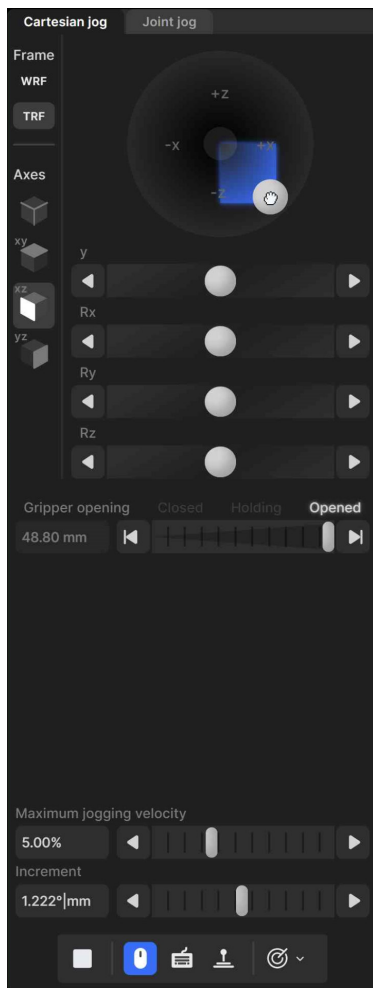

(a) Cartesian jogging using the primary mouse button

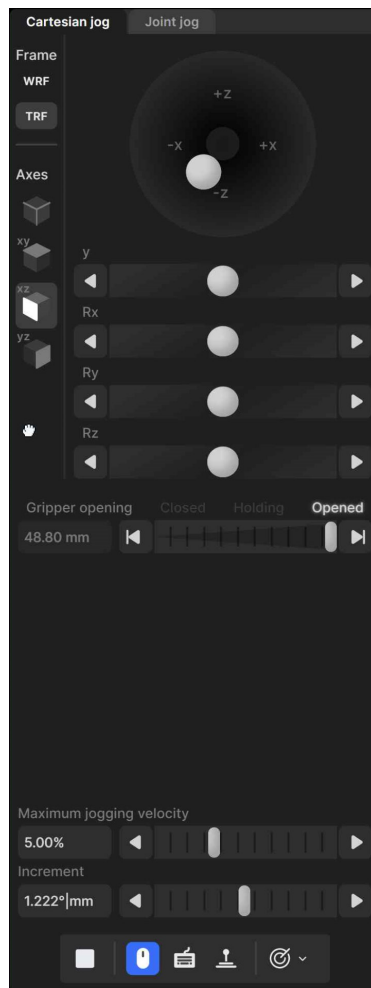

(b) Cartesian jogging using the secondary mouse button

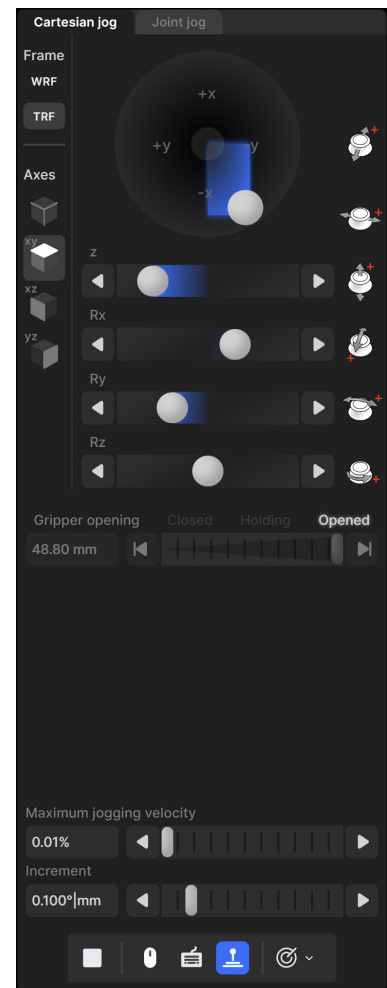

(c) Cartesian jogging using the SpaceMouse

Figure 23: Cartesian jog tab

The other major difference is that there are no text fields showing the position and orientation of the TRF with respect to the WRF, next to each jogging bar, let alone visual cues for indicating whether Cartesian jogging in one direction might soon reach a workspace limit. This is mainly because, in general, jogging along and about the three axes of a reference frame have no one-to-one correlation to the position coordinates and Euler angles used to represent the pose of the TRF with respect to the WRF. Furthermore, other than mechanical interferences between non-adjacent links of the robot (which will soon be avoidable), the factors that limit the robot workspace are the joints limits and the singularities, which are already displayed in the robot position display, in the top right corner of the MecaPortal.

The keyboard shortcuts for Cartesian jogging are shown in [Table 11](#).

Finally, you can jog in Cartesian mode using a joystick. [Figure 23c](#) shows the Cartesian jog tab in the case of the SpaceMouse.



Having multiple input modes for jogging activated simultaneously is unsafe. You should enable only one input mode at a time: the mouse, keyboard shortcuts, or the joystick.



In Cartesian jog, when reorienting the end-effector using the Rx, Ry and Rz arrow buttons, you do not modify independently each Euler angle, but rather rotate the TRF about axes passing through its origin (the TCP) and coincident with its x, y or z axes, if the TRF option is chosen, or parallel to the x, y or z axes of the WRF, if the WRF option is chosen.

6.8. The configuration menu

The configuration menu can be accessed from the top left corner of the MecaPortal window, . It features the following sections:

- Robot information, such as the serial number and the complete version number of the firmware;
- Help, primarily links to documentation, the support website, and to the legacy web interface;
- Network configuration, such as entries of the IP address of the robot or the netmask,
- Joint limits, for reducing the joint ranges;
- Work zone limits and collision configuration, for preventing self-collisions and defining a work zone;
- Update firmware, for upgrading (or downgrading) the firmware of the robot;
- Get logs and backup, for downloading a complete backup (robot logs, persistent configuration data, programs, etc.) or the latest robot logs only;
- Keyboard mapping, for listing all and changing certain keyboard shortcuts;
- Joystick mapping, for assigning robot jogging directions to joystick axes.

For example, when using the SpaceMouse for Cartesian jogging, it is particularly helpful to assign the axes of the SpaceMouse so that they are aligned with the axes of the WRF as shown in [Figure 24](#). Jogging in Cartesian mode, with the WRF option selected, becomes extremely intuitive.

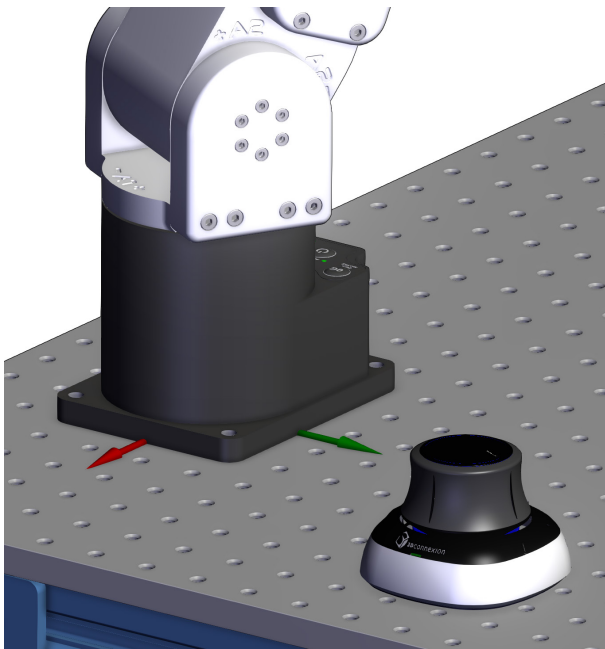

(a) Example of the relative placement of the SpaceMouse with respect to the WRF

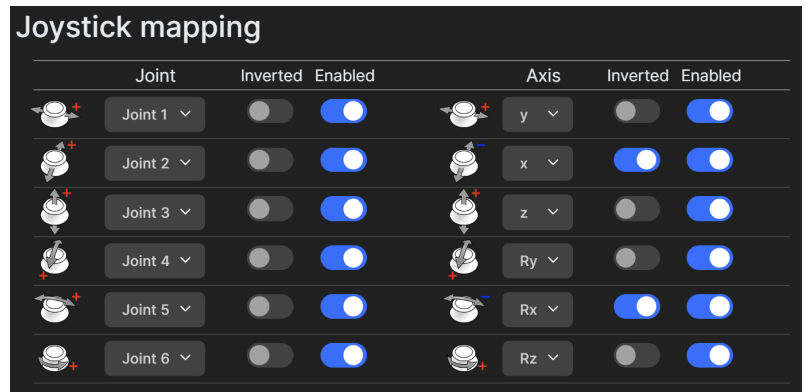

(b) The changes that must be made in the configuration menu

Figure 24: Example of configuring the axes of the SpaceMouse

7. OPERATING THE SMART POWER SUPPLY

The R4 version of Mecademic's power supply is shown in [Figure 25](#). The R3 version is visually identical to the R4 version, except for some of the engravings. However, there are some hardware differences. Therefore, never use an R3 power supply with a Meca500 R4 or an R4 power supply with a Meca500 R3. The D-Sub dongle is, however, identical in both versions.



Figure 25: The PS200-R4 smart power supply

7.1. Emergency, protective and software stops

The power supply is equipped with

- one E-STOP button (Stop Category 1), designed to achieve PL=d,
- one RESET button,

and safety I/O connections for

- one external E-Stop (Stop Category 1),
- one external protective stop (Stop Category 1) that will be referred to as P-Stop 1,
- one external software stop that will be referred to as SWStop (not safety-rated),
- one external Reset,
- one motor power status indicator.

The E-STOP button, the external E-Stop, and the P-Stop 1 (safety chain) are inter-related in an OR logic, and are designed to achieve PL=d. In other words, activating any of the two E-Stops or removing power to the P-Stop 1 has the same effect: removing power from the motors of the robot, from the brakes disengaging mechanisms, and from the robot's EOAT (if R4) or in the complete robot (if R3). To give power to the motors, both emergency stops must be released and power to the P-Stop 1 must be

applied. Therefore, for simplicity, in the rest of this subsection, we will only refer to the E-STOP button on the power supply.

Similarly, the RESET button on the power supply and the external Reset are inter-related in an OR logic. Pressing either of these yields the same action, as long as the other button is released. Therefore, for simplicity, in the rest of this subsection, we will only refer to the RESET button on the power supply.

Once you power up the robot, you must make sure the E-STOP button is released. Then, pressing the RESET button sends power to the robot motors and to the EOAT (if R4) or to the complete robot (if R3).

Once the robot is activated and homed, pressing the E-STOP button at any time instantly sends a signal to the robot to rapidly decelerate and come to a complete stop. The power supply then waits for a signal from the robot indicating that the robot is completely stopped, and as soon as that signal is received, but no later than in 500 ms, the power supply completely cuts power to the robot, in the case of R3 version, or only to the robot motors and Mecademic' EOAT, in the case of R4 version. In both cases, the robot brakes are then automatically applied to joints 1, 2 and 3. To use the robot again, you must release the E-STOP button, and press the RESET button, then activate and home the robot.

Of course, you will also need to manage the stream of commands being sent to the robot. For example, if a PLC sends commands to the robot, while the robot is powered off, the program that runs on your PLC will need to be able to detect and manage this situation. To do so, you can get a signal from the power supply that an E-STOP has been pressed by connecting your PLC to the D-Sub connected, as will be explained in the following pages. In the case of the R4 version, the event is also reported by the robot controller.

7.2. LEDs

The power supply is equipped with three LEDs. As long as the power supply is switched on (using its on/off button) and connected to an AC source that supplies voltage at 90–250 V at frequency of 50–60 Hz, the green LED next to "Power" stays illuminated. Supplying AC voltage outside this range may damage the power supply.

Once the power supply is switched on, the yellow Status LED indicates the status of the power supply. If the yellow LED is off, you need to press the RESET button, which sends power to the robot. If the proper Meca500 is correctly connected to the power supply, the yellow LED will turn on and stay lit.

If, in any situation, the yellow LED blinks regularly, this means that an emergency stop (either the one on the power supply or the external one) or the external SWStop is activated. You need to release the emergency stop or remove the cause for the SWStop and then press the RESET button.

If the yellow LED illuminates in sets of two flashes, this means that the integrated or external RESET button has been pressed too long. Make sure they are not pressed and then quickly press any of them.

Finally, the red Error LED indicates if there is a problem with the power supply or with some of the connections to the D-Sub interface. If the red LED flashes (0.1 s on, 0.9 s off), either there is no robot connected to the power supply or the robot connected is an old version that is not supported by this power supply. If the red LED illuminates in sets of two quick flashes, the robot has detected a problem and sent a request to the power supply to be shut down. If this happens, contact us. If the red LED blinks in regular intervals (0.5 s on, 0.5 s off), this means that there is either a problem in your external emergency stop or Stop Category 1 connections or in our power supply. If you don't see any problem in your connections, contact us. Finally, if the red LED is constantly lit, there is a problem with the power supply. Switch off the power supply and contact us.

Table 12 summarizes the different states of the three LEDs as well as their meanings.

Table 12: The various states of the LEDs on the power supply

POWER SUPPLY LEDS			
LED	Name	LED state	Explanation
Green	Power	Off	The power supply is turned on
		On	The power supply is turned off
Yellow	Status	Off	Robot is not powered. Press RESET.
		Blinking	Robot is not powered and a Stop Category 1 stop is pressed or the dongle is not plugged in. Remedy the situation and press RESET.
		Two flashes	Robot is not powered because a RESET button has been pressed for too long. Press RESET again.
		On	Robot is powered.
Red	Error	Off	There is no error.
		Flashes	No proper robot connected.
		Two flashes	Robot has detected a problem and requested that power be shut down. Contact our support team.
		Blinking	Problem with Stop Category 1 stops detected. Check external stop connections and contact our support team if no solution found.

7.3. External connections

The D-Sub dongle is a temporary bypass device. After performing a risk assessment for your installation, you must design and connect the appropriate safety circuit to the D-Sub connector. Figure 30 shows the pinout of that connectors.

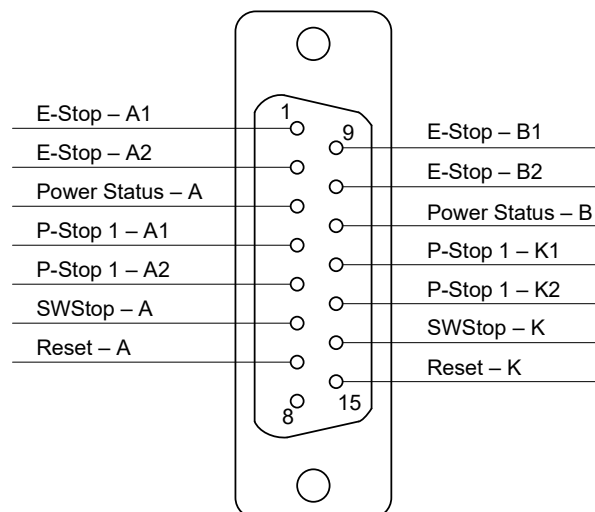

Figure 26: Pinout of the D-Sub connector on Meca500's power supply



Never connect or remove the D-Sub dongle or add or remove safety I/O connections, while the power supply is on.

As already mentioned, you can connect:

- one Stop Category 1 emergency stop (pins E-Stop – A1, E-Stop – B1, E-Stop – A2, E-Stop – B2);
- one Stop Category 1 protective stop (pins P-Stop 1 – A1, P-Stop 1 – K1, P-Stop 1 – A2, P-Stop 1 – K2);
- one software stop (pins SWStop – A, SWStop – B);
- one reset (pins Reset – A, Reset – K);
- one power status indicator (pins Power Status – A, Power Status – B).

7.3.1 Stop Category 1 Emergency Stop

The external E-Stop performs the same function as the E-Stop on the power supply. The terminals of the external E-Stop are connected in series with the E-Stop on the power supply. [Figure 27](#) shows two examples for the wiring of the four external E-Stop terminals. You may also, for example, connect several E-Stops in series or use a safety PLC. If you choose not to use any external E-Stop, remember to wire the pins as in [Figure 27b](#).

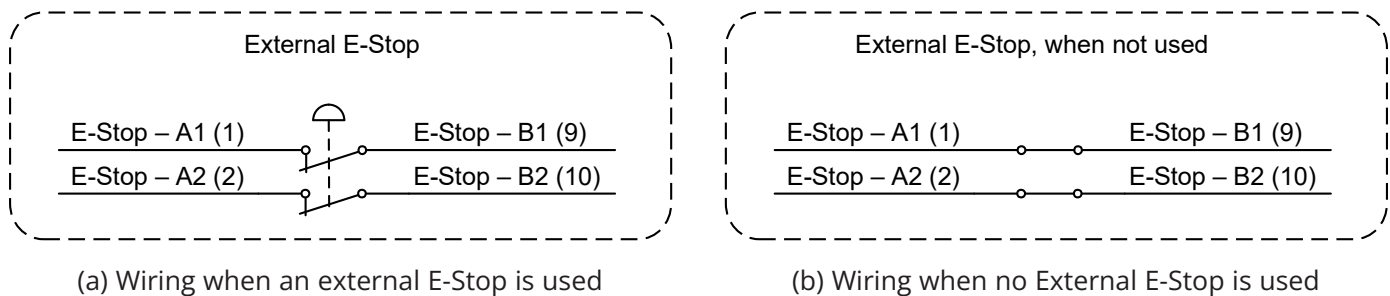

Figure 27: Examples of wiring of the external E-Stop connections



The external E-Stop circuit must be closed for the robot to be able to move.

7.3.2 Stop Category 1 Protective Stop (P-Stop 1)

[Figure 28](#) shows the wiring diagram for the P-Stop 1 terminals in the case of the R3 and R4 versions of the Meca500. The P-Stop 1 signal would generally come from a safety PLC, which will be connected to a safety switch such as a safety light curtain or an interlock door switch.

Note, however, that in the R3 version, the current that reaches the power supply at the P-Stop 1 terminals must be a 24mA continuous forward current. This is why the use of proper resistances is compulsory in the R3 (see [Figure 28a](#)), or else you will damage the power supply.

In the case of the Meca500 R4, a current limiting circuitry has been implemented, and the use of a resistance is not necessary.

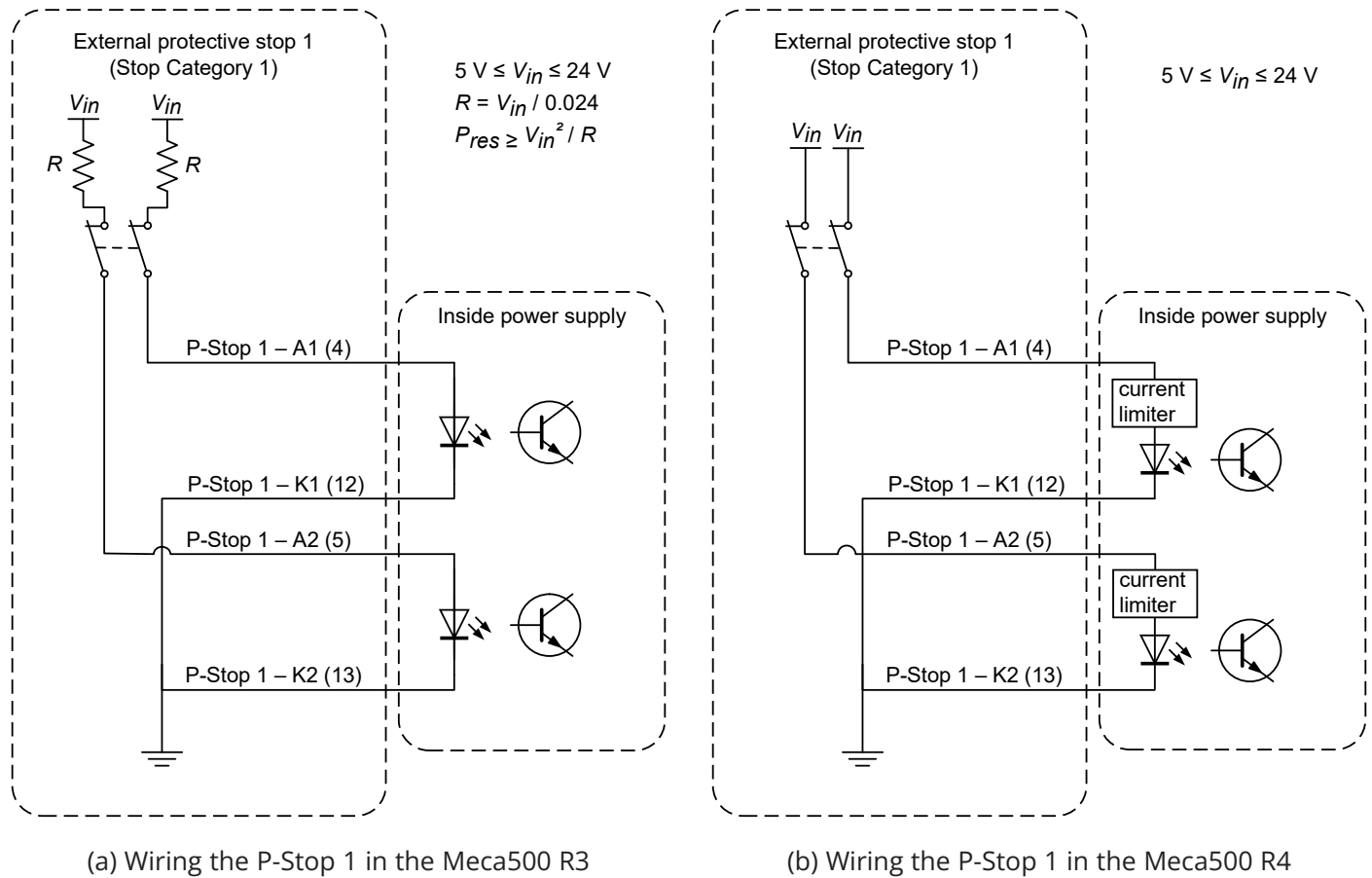

Figure 28: Examples of wiring the P-Stop 1 in the Meca500 R3 and R4



In the Meca500 R3, you **MUST USE RESISTANCES** to limit to current applied to the P-Stop 1 terminals to 24mA, or else you will damage the power supply.



The P-Stop 1 circuit must be closed for the robot to be able to move.

7.3.3 Software Stop (SWStop)

The software stop is essentially equivalent to sending the command `PauseMotion`.

The SWStop signal would normally come from a safety PLC. Simple examples for the wiring diagrams in the case of the R3 and R4 versions of the Meca500 are shown in [Figure 29](#). The same specifications for the input voltage and current apply, as in the case of the P-Stop 1, as shown in [Figure 29](#).



In the Meca500 R3, **YOU MUST USE RESISTANCES** to limit to current applied to the SWStop terminals to 24 mA, or else you will damage the power supply.



The software stop marked SWStop is not a safety-rate protective stop.



The SWStop circuit must be open for the robot to be able to move.

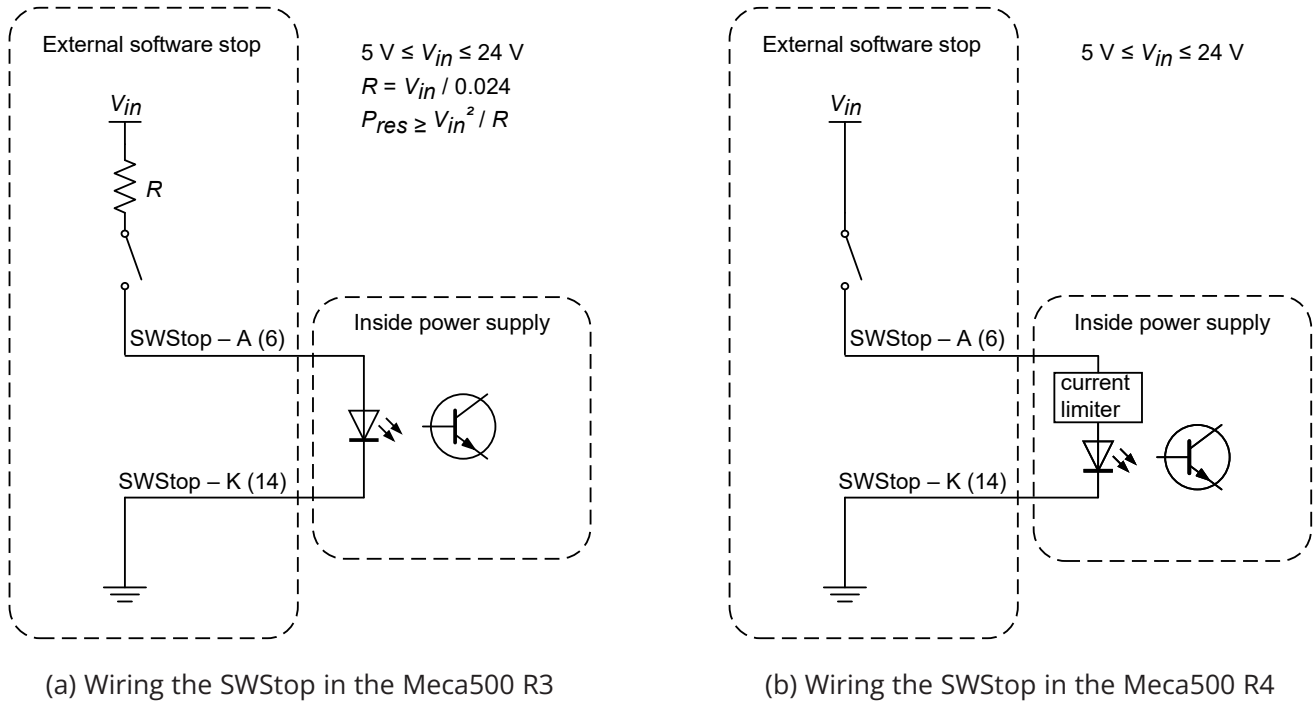

Figure 29: Examples of wiring the SWStop in the Meca500 R3 and R4

7.3.4 External Reset

The external reset connection performs the same function as the Reset button on the power supply. The terminals of the external reset are connected in parallel with the E-Stop on the power supply.

The external reset signal would normally come from a safety PLC. Simple examples for wiring diagrams in the case of the R3 and R4 versions of the Meca500 are shown in [Figure 30](#). The same specifications for the input voltage and current apply, as in the case of the SWStop, as shown in [Figure 30](#).

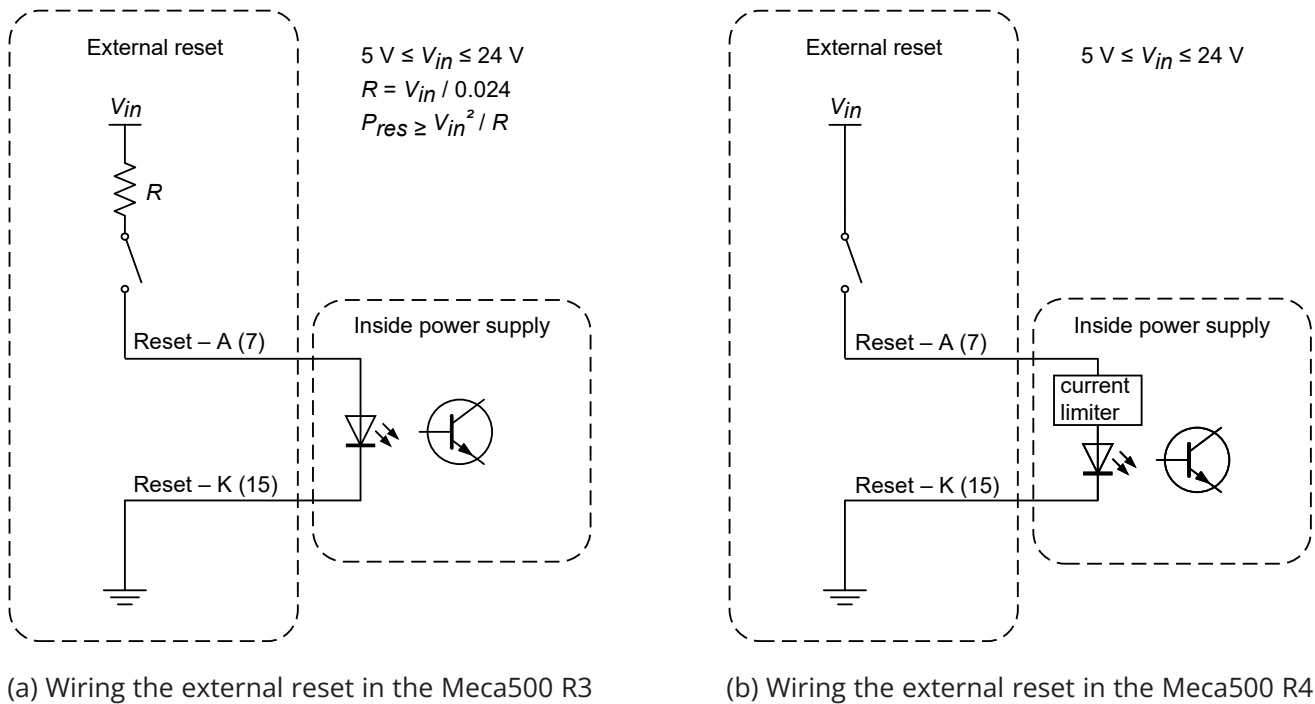

Figure 30: Examples of wiring the external reset in the Meca500 R3 and R4



In the Meca500 R3, YOU MUST USE RESISTANCES to limit to current applied to the external reset terminals to 24mA, or else you will damage the power supply.

7.3.5 Power Status

The power status terminals provide an output signal that corresponds to the power state of the robot (in the case of R3) or of the robot motors (in the case of R4). The current on these terminals is limited to 60 mA, and the voltage to 24 V (DC). There is no difference between the R3 and R4 with regards to the power status connection.

Two examples of wiring the power status terminals are given in [Figure 31](#).



In both the R3 and R4 versions of the Meca500, the maximum voltage applied at the power status terminals must be 24 V (DC), and the maximum current must be limited to 60 mA.

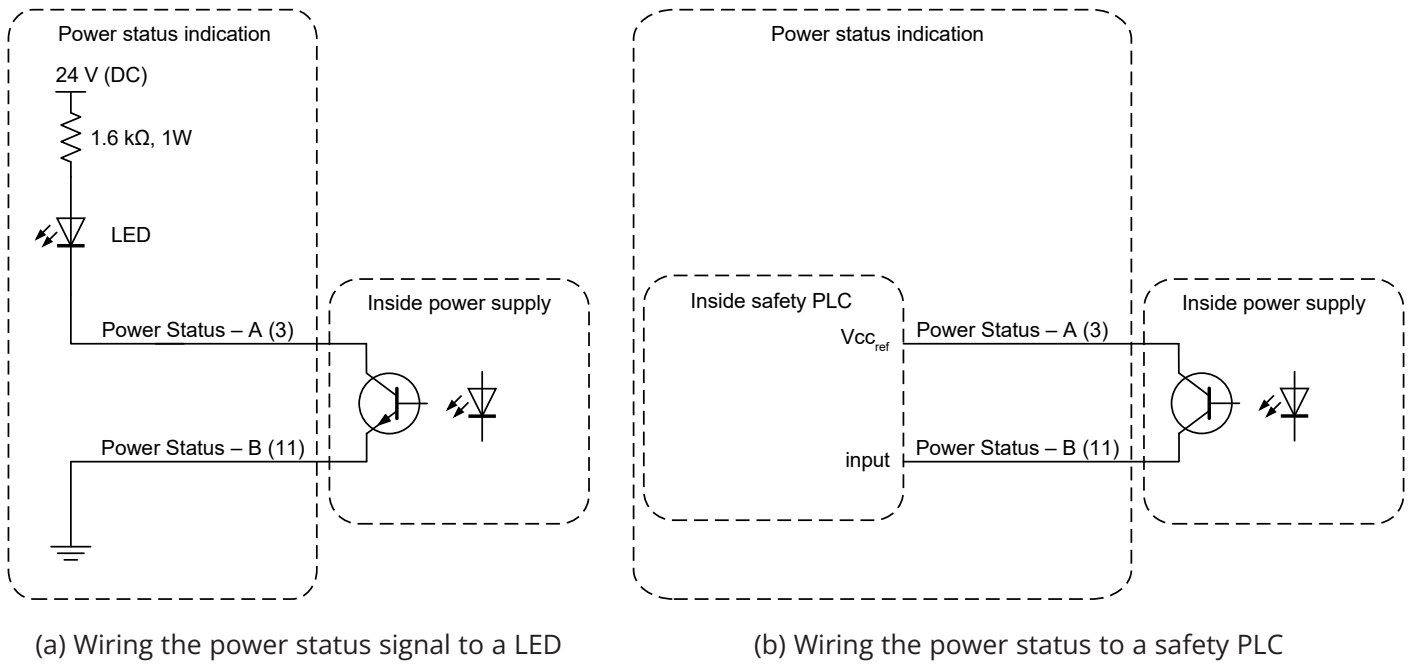

Figure 31: Examples of wiring the power status in the Meca500 R3 and R4

8. INSTALLING AN END-EFFECTOR

The Meca500 comes with a proprietary tool I/O (input/output) port located at the robot extremity (Figure 32a). However, this tool port is reserved uniquely for our end-of-arm-tooling (EOAT), i.e., our electric grippers MEGP 25E and MEGP 25LS, and our pneumatic module MPM500. We do not share the pinout of this port or its custom-made communication protocol. To install our grippers or pneumatic module, refer to their user manuals.

If you want to use any other end-effector with the Meca500, you will need to control it independently from the Meca500. You can attach the cabling of your end-effector along the robot arm using adhesive-backed tie mounts. Finally, you must fix the end-effector to the robot's flange (Figure 32b) using four M3 screws tightened at 1.5 Nm, and, optionally, one $\varnothing 3$ locating pin, all of properly selected length.



- Keep the robot unpowered while installing/removing a tool to its flange.
- Do not exceed the robot payload (0.5 kg).
- Do not exceed 3.4 Nm for the moment load on the robot flange.
- Securely fasten the tool to the robot flange.

Note that since joint 6 is multi-turn, there is no way of knowing the angle of joint 6 (even approximately), unless the robot is activated and homed. Therefore, prior to mounting an end-effector, it is important that you activate and home your robot, rotate joint 6 to its zero position, and finally unpower the robot. However, if the screw on the flange of the robot is not as in Figure 32a when $\theta_6 = 0^\circ$, then you need to follow the procedure described in Section Homing of the Programming Manual.



(a) closeup

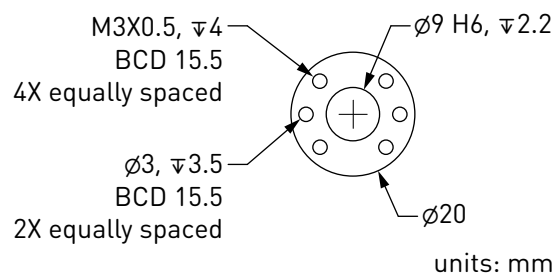

(b) dimensions

Figure 32: The mechanical interface (flange) of the Meca500. The flange is the $\varnothing 20$ disk, inside the black isolation ring, and is the only one to rotate when joint 6 rotates.



- Make sure that joint 6 is approximately at 0° before attaching an end-effector.
- Tighten the M3 screws with a torque of 1.5 Nm and a thread penetration of 4 mm. Do not thread more than 4 mm into the flange or else you may damage the gearbox of joint 6.
- Attach the tool cabling in such a manner that it obstructs as little as possible the motions of the robot.
- Unless you plug the connector of one of our own EOAT, keep the cover (screw cap, not shown in Figure 32a) of the tool I/O port in place at all times.

9. EXAMPLES

9.1. Draw a square

Here is an example of a very simple program that makes the robot's TCP follow a square path, using the MoveLin command :

```

ActivateRobot
Home
MoveJoints(0,0,0,0,0,0)
MovePose(140,-100,250,0,90,0)
MoveLin(140,100,250,0,90,0)
MoveLin(270,100,250,0,90,0)
MoveLin(270,-100,250,0,90,0)
MoveLin(140,-100,250,0,90,0)
MoveJoints(0,0,0,0,0,0)
    
```

Figure 33 shows the result of four of the motion commands.

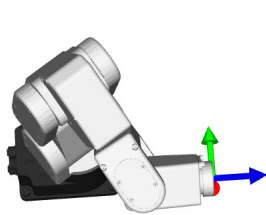

(a) MovePose(140,-100,250,0,90,0)

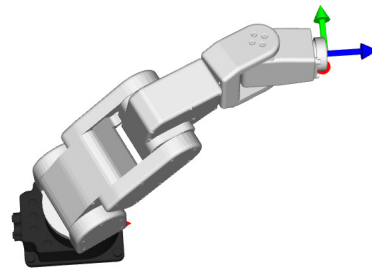

(b) MoveLin(270,100,250,0,90,0)

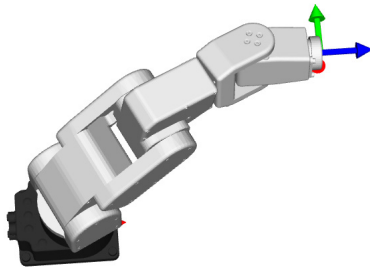

(c) MoveLin(270,-100,250,0,90,0)



(d) MoveLin(140,-100,250,0,90,0)

Figure 33: The four separate robot positions that define the motion sequence

10. INSPECTION AND MAINTENANCE

The Meca500 requires no maintenance, but we recommend that you inspect it every three months and before storing it for more than a month, to ensure that it is still functioning properly. Proceed with the following list of verifications, in that order.

Locking up the power supply

Follow the procedure described in [Section 2.2.1](#).

Cleaning

Turn off the power supply and wipe away any dust or dirt observed on the robot arm using a soft, lint-free cloth and Isopropyl alcohol. Never use compressed air to clean the robot arm.

Visual and functional inspection

1. Turn the power on, activate and home the robot, and then move all joints to their zero position. The robot must look like in Figure 1 of the Programming Manual. If only joint 6 is offset, follow the procedure given in the section Homing of the Programming Guide.
2. Turn the power off and disconnect the power cable from both the robot and the power supply unit (PSU). Inspect the cable and the two connectors for any damage.
3. Verify that the four M6 screws on the base of the robot are sufficiently tightened. They must be tightened with a torque of 3 Nm.
4. Verify that the four M3 screws attaching your tool to the flange of the robot are sufficiently tightened. They must be tightened with a torque of 1.5 Nm.
5. If you have an MEGP 25E* gripper or an MPM500 pneumatic module disconnect the tooling cable and inspect the tool port and cable for any damage. Then, screw in the cable and validate that the cable is not loose.

Safety inspection

1. Turn the power on, activate and home the robot, and then execute a large motion at high velocity. Quickly, while the robot is still moving, press the E-STOP button and verify whether the robot stops immediately.
2. If you have an R3 version, turn the power on, activate and home the robot. Bring your robot to a fully-stretched horizontal position by executing the command `MoveJoints(0,90,-90,0,0,0)`, or to the most stretched position that is free of mechanical interferences. Then turn the power off and verify whether the brakes of joints 1, 2 and 3 are stiff enough.

11. TROUBLESHOOTING

No LEDs are on upon power up

- Make sure all connectors are properly attached.
- Make sure the AC outlet works (the green LED on the power supply should be on).

No connection to the robot's web interface

- Make sure EtherCAT mode has not been enabled. To switch the robot back to Ethernet TCP/IP mode, the simplest way is to do a network configuration reset. This can be done by performing a network configuration reset.
- Make sure the router/switch works by checking the LEDs of the connection socket.
- Make sure you are connected to the same network as the robot.
- If you are using static IP addresses, make sure that the robot's IP default address (192.168.0.100) does not conflict with any other device on the network. For example:

Robot: IP = 192.168.0.100, netmask = 255.255.255.0, gateway = 192.168.0.1

Computer: IP = 192.168.0.101, netmask = 255.255.255.0, gateway = 192.168.0.1

- If you are using DHCP, make sure to verify the robot's IP address via your router's web interface.
- Make sure you do not have a firewall preventing traffic on TCP ports 80, 10010 and 10011. These ports are used by the MecaPortal for communicating with the robot.
- Make sure the Ethernet cable is properly connected. The green Ethernet LED should pulse like on an RJ-45 connector when there is communication between the robot and the computer. If the green LED is not illuminated, detach and reconnect the Ethernet cable.

Robot fails to boot

- Disconnect the power supply from the AC outlet and wait for the green LED of the power supply to turn off. Then reconnect the power supply and boot the robot.

Robot's IP address forgotten

- You can reset the robot's Ethernet configuration (i.e., set the robot's IP address to 192.168.0.100 and the communications mode to TCP/IP) by performing a network configuration reset.

Network configuration reset

- Power off the robot;
- On the Meca500 R4, press the E-Stop for safety reasons.
- Press the Power button on the robot base while powering on the robot and keep button pressed for about 40 seconds until the red and yellow LEDs on the robot base start to blink sequentially.

Factory reset

- On the Meca500, it is not possible to perform a factory reset, initializing all persistent configuration data and erasing all user programs.

Storing the robot in its shipping box

To put the Meca500 back into the foam insert of its original shipping box, send the command `MoveJoints(0, -60, 60, 0, 0, 0)`. Recall that you must not force the brakes on joints 1, 2 and 3.



Never disassemble the robot. The robot requires no maintenance, and if you think it is damaged, stop using it immediately and contact us.



If you are unable to solve your technical problem, do not hesitate to contact our technical support team by creating a ticket at <https://support.mecademic.com>.

12. DECOMMISSIONING

Even when the Meca500 reaches the end of its product's life cycle or is deemed to be damaged beyond repair, we encourage you to contact us to verify if complete disposal can be avoided.

If you do decide to dispose of the Meca500 system (robot arm, power supply and cables), you must do so in accordance with the applicable national laws, regulations and standards.

The Meca500 system is produced with restricted use of hazardous substances to protect the environment; as defined by the European RoHS directive 2011/65/EU. These substances include mercury, cadmium, lead, chromium VI, polybrominated biphenyls and polybrominated diphenyl ethers. Specialized organisms can dismantle the unit and sort out these materials. They can also remove and recycle the aluminum parts of the robot.

If the robot is not contaminated, you can also ship it back to us.

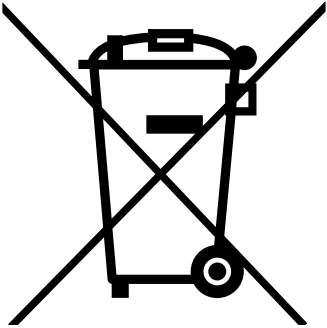

APPENDIX 1. MECA500 R4 EMC TEST RESULTS

Table 13 lists all the tests passed by the Meca500 R4, called by the harmonized standards related to electromagnetic compatibility.

Table 13: Summary of EMC test results for the Meca500 R4

SUMMARY OF TEST RESULTS			
Test Name / Standards	Test specifications	Minimum performance criterion required	Result
Conducted Emissions FCC part 15 (2021) subpart B	Class A 150kHz–30MHz	n/a	Pass
Radiated Emissions FCC part 15 (2021) subpart B	Class A 30MHz–6GHz	n/a	Pass
Conducted Emissions ICES-001 Issue 5 (2020)	Group 1 - class A 150kHz–30MHz	n/a	Pass
Conducted Emissions ICES-001 Issue 5 (2020)	Group 1 - class A 150kHz–30MHz	n/a	Pass
Radiated Emissions ICES-001 Issue 5 (2020)	Group 1 - class A 30MHz–1GHz	n/a	Pass
Conducted Emissions CISPR 11 (2015) A1 (2016) A2 (2019)	Class A 150kHz–30MHz	n/a	Pass
Radiated Emissions CISPR 11 (2015) A1 (2016) A2 (2019)	Class A 30MHz–5GHz	n/a	Pass
Electrostatic Discharge Immunity IEC61000-4-2 (2008)	Contact: $\pm 4\text{kV}$ Air: $\pm 2\text{kV}$, $\pm 4\text{kV}$, $\pm 8\text{kV}$	B	Pass
Radiated Electromagnetic Field Immunity IEC 61000-4-3 (2020)	80MHz–1000MHz: 10V/m 1.4GHz–6GHz: 3V/m	A	Pass
Electrical Fast Transient Immunity IEC61000-4-4 (2012)	Power: $\pm 2\text{kV}$ / 5kHz I/O Ports: $\pm 1\text{kV}$ / 5kHz Communication Ports: $\pm 1\text{kV}$ / 5kHz	B	Pass
Surge Immunity IEC 61000-4-5 (2014) A1 (2017)	Power: $\pm 2\text{kV}$ L-PE / $\pm 1\text{kV}$ L-L I/O Ports: N/A Communication Ports: N/A	B	Pass
Immunity to Conducted Disturbances, Induced by Radio-Frequency Fields IEC61000-4-6 (2013)	Power: 3V I/O Ports: 3V Communication Ports: 3V	A	Pass
Power Frequency Magnetic Field Immunity IEC61000-4-8 (2009)	Continuous Field: 30A/m / 50Hz & 60Hz	A	Pass

Table 13: Summary of EMC test results for the Meca500 R4 (continued)

SUMMARY OF TEST RESULTS			
Test Name / Standards	Test specifications	Minimum performance criterion required	Result
Voltage Dips, Short Interruptions and Voltage Variation Immunity on AC Input IEC 61000-4-11 (2020)	Voltage dips: 0%Un during 1 cycle 40%Un during 10 cycles (at 50Hz) 40%Un during 12 cycles (at 60Hz) 70%Un during 25 cycles (at 50Hz) 70%Un during 30 cycles (at 60Hz) Short interruptions: 0%Un during 250 cycles(at 50Hz) 0%Un during 300 cycles (at 60Hz)	B C C C C C C C	Pass

APPENDIX 2. MECA500 R3 EMC TEST RESULTS

Table 14 lists all the tests passed by the Meca500 R3, called by the harmonized standards related to electromagnetic compatibility.

Table 14: Summary of EMC test results for the Meca500 R3

SUMMARY OF TEST RESULTS			
Test Name / Standards	Test specifications	Minimum performance criterion required	Result
Conducted Emissions FCC part 15 (2018) subpart B	Class A 150kHz–30MHz	n/a	Pass
Radiated Emissions FCC part 15 (2018) subpart B	Class A 30MHz–5GHz	n/a	Pass
Conducted Emissions CISPR11 (2015) A1 (2016)	Group 1 - class A 150kHz–30MHz	n/a	Pass
Radiated Emissions CISPR11 (2015) A1 (2016)	Group 1 - class A 30MHz–1GHz	n/a	Pass
Conducted Emissions ICES-003 (2016)	Class A 150kHz–0MHz	n/a	Pass
Radiated Emissions ICES-003 (2016)	Class A 30MHz–5GHz	n/a	Pass
Electrostatic Discharge Immunity IEC61000-4-2 (2008)	Contact: ±4kV Air: ±8kV	B	Pass
Radiated Electromagnetic Field Immunity IEC61000-4-3 (2006) A1 (2007) A2 (2010)	80MHz–1000MHz: 10V/m 1.4GHz–6GHz: 3V/m 2GHz–2.7GHz: 1V/m	A	Pass
Electrical Fast Transient Immunity IEC61000-4-4 (2012)	Power: ±2kV / 5kHz I/O Ports: ±1kV / 5kHz Communication Ports: ±1kV / 5kHz	B	Pass
Surge Immunity IEC61000-4-5 (2014)	Power: ±2kV L-PE / ±1kV L-L I/O Ports: N/A Communication Ports: N/A	B	Pass
Immunity to Conducted Disturbances, Induced by Radio-Frequency Fields IEC61000-4-6 (2013)	Power: 3V I/O Ports: 3V Communication Ports: 3V	A	Pass
Power Frequency Magnetic Field Immunity IEC61000-4-8 (2009)	Continuous Field: 30A/m / 50Hz & 60Hz	A	Pass

Table 14: Summary of EMC test results for the Meca500 R3 (continued)

SUMMARY OF TEST RESULTS			
Test Name / Standards	Test specifications	Minimum performance criterion required	Result
Voltage Dips, Short Interruptions and Voltage Variation Immunity on AC Input IEC61000-4-11 (2004)	Voltage dips: 0%Un during 1 cycle 40%Un during 10 cycles (at 50Hz) 40%Un during 12 cycles (at 60Hz) 70%Un during 25 cycles (at 50Hz) 70%Un during 30 cycles (at 60Hz) Short interruptions: 0%Un during 250 cycles(at 50Hz) 0%Un during 300 cycles (at 60Hz)	B C C C C C C C	Pass

Contact Us

Mecademic
1300 St-Patrick Street
Montreal (Quebec) H3K 1A4
Canada

1-514-360-2205
1-833-557-6268 (toll-free in North America)

<https://support.mecademic.com>

MECADEMIC
INDUSTRIAL ROBOTICS

© Copyright 2015–2024 Mecademic